

# Operating Instructions

## DVD Video Recorder

Model No. **DMR-E65**

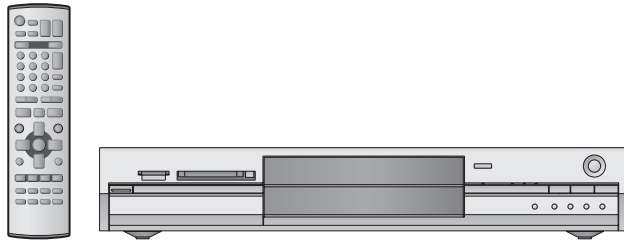

# DIGA

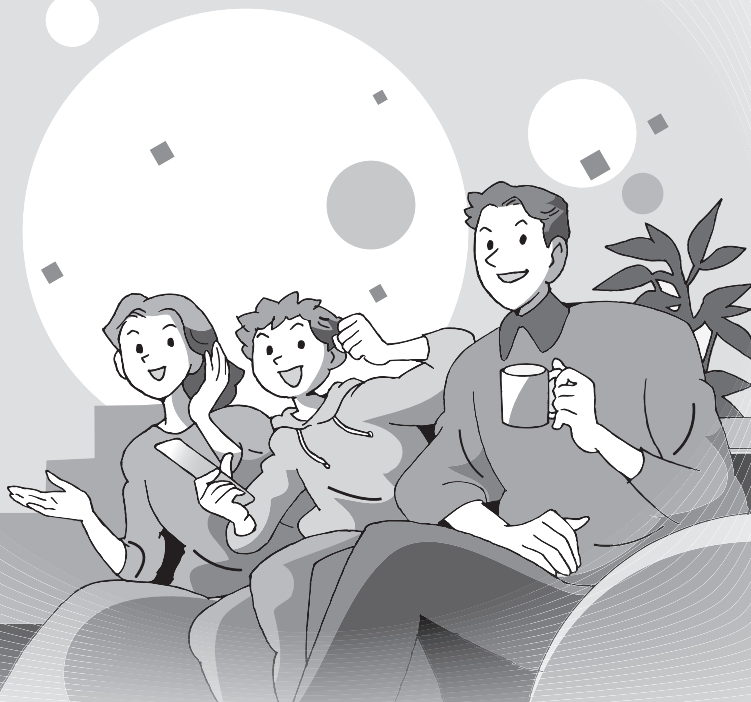

GN

# Panasonic®

### Region number supported by this unit

Region numbers are allocated to DVD players and software according to where they are sold.

- The region number of this unit is "4".
- The unit will play DVDs marked with labels containing "4" or "ALL".

Example:



### Dear customer

Thank you for purchasing this product. For optimum performance and safety, please read these instructions carefully.

Before connecting, operating or adjusting this product, please read these instructions completely. Please keep this manual for future reference.

RQT7450-L

**CAUTION!**

THIS PRODUCT UTILIZES A LASER.  
USE OF CONTROLS OR ADJUSTMENTS OR  
PERFORMANCE OF PROCEDURES OTHER THAN THOSE  
SPECIFIED HEREIN MAY RESULT IN HAZARDOUS  
RADIATION EXPOSURE.  
DO NOT OPEN COVERS AND DO NOT REPAIR YOURSELF.  
REFER SERVICING TO QUALIFIED PERSONNEL.

**WARNING:**

TO REDUCE THE RISK OF FIRE, ELECTRIC SHOCK OR  
PRODUCT DAMAGE, DO NOT EXPOSE THIS APPARATUS  
TO RAIN, MOISTURE, DRIPPING OR SPLASHING AND THAT  
NO OBJECTS FILLED WITH LIQUIDS, SUCH AS VASES,  
SHALL BE PLACED ON THE APPARATUS.

**CAUTION!**

- DO NOT INSTALL OR PLACE THIS UNIT IN A BOOKCASE,  
BUILT-IN CABINET OR IN ANOTHER CONFINED SPACE.  
ENSURE THE UNIT IS WELL VENTILATED. TO PREVENT  
RISK OF ELECTRIC SHOCK OR FIRE HAZARD DUE TO  
OVERHEATING, ENSURE THAT CURTAINS AND ANY  
OTHER MATERIALS DO NOT OBSTRUCT THE  
VENTILATION VENTS.
- DO NOT OBSTRUCT THE UNIT'S VENTILATION OPENINGS  
WITH NEWSPAPERS, TABLECLOTHS, CURTAINS, AND  
SIMILAR ITEMS.
- DO NOT PLACE SOURCES OF NAKED FLAMES, SUCH AS  
LIGHTED CANDLES, ON THE UNIT.
- DISPOSE OF BATTERIES IN AN ENVIRONMENTALLY  
FRIENDLY MANNER.

THIS UNIT IS INTENDED FOR USE IN MODERATE CLIMATES.

This product may receive radio interference caused by mobile  
telephones during use. If such interference is apparent, please  
increase separation between the product and the mobile  
telephone.

The socket outlet shall be installed near the equipment and  
easily accessible or the mains plug or an appliance coupler shall  
remain readily operable.



DANGER	- VISIBLE AND INVISIBLE LASER RADIATION WHEN OPEN. AVOID DIRECT EXPOSURE TO BEAM. (FDA 21 CFR)
CAUTION	- VISIBLE AND INVISIBLE LASER RADIATION WHEN OPEN. AVOID EXPOSURE TO BEAM. (IEC60825-1)
ATTENTION	- RAYONNEMENT LASER VISIBLE ET INVISIBLE EN CAS D'OUVERTURE. EXPOSITION DANGEREUSE AU FAISCEAU.
ADVARSEL	- SYNLIG OG USYNLIG LASERSTRÅLING VED ÅBNING. UNNGÅ UDSEJTELSE FOR STRÅLING.
VARO!	- AVATTAESSA OLET ALLTTIINA NÄKYVÄÄ JA NÄKYMÄTÖN LASERSÄTEILYLLE. ÄLÄ KATSO SÄTEESEEN.
VARNING	- SYNLIG OCH OSYNLIG LASERSTRÅLNING NÄR DENNA DEL ÄR ÖPPNAD. BETRAKTA EJ STRÅLEN.
ADVARSEL	- SYNLIG OG USYNLIG LASERSTRÅLING NÄR DEKSEL ÅPNES. UNNGÅ EKSPONERING FOR STRÅLEN.
VORSICHT	- SICHTBARE UND UNSICHTBARE LASERSTRÄHLUNG, WENN ABDECKUNG GEÖFFNET. NICHT DEM STRAHL AUSSETZEN.
注意	- 打开时有可见及不可见激光辐射。避免激光束照射。
注意	- ここを開くと可視及び不可視のレーザー光が出ます。 ビームを直接見たり、触れたりしないでください。 RQLS0233

(Inside of product)

Keep the small memory cards such as the SD  
Memory Card out of reach of children. If  
swallowed, seek medical advice immediately.

# Table of contents

## Getting started

Accessories .....	3
Useful features .....	4
The remote control .....	4
Control reference guide .....	5
<b>STEP 1 Connection</b> .....	6
<b>STEP 2 Channel reception settings</b> .....	9
<b>STEP 3 Set up to match your television and remote control</b> .....	10
To enjoy progressive video .....	10
<b>Disc and card information</b> .....	12

## Recording

<b>Recording television programmes</b> .....	14
Recording modes and approximate recording times .....	15
Playing while you are recording .....	15
Flexible Recording .....	16
<b>Timer recording</b> .....	17
Using G-CODE® system to make timer recordings .....	17
Manually programming timer recordings .....	18
Check, change or delete a programme .....	19

## Playing back

<b>Playing recorded video contents/Playing play-only discs</b> .....	20
Operations during play .....	21
Editing operations during play .....	22
Changing audio .....	22
<b>Using menus to play MP3</b> .....	23
<b>Playing still pictures</b> .....	24
Useful functions during still picture play .....	25
<b>Using on-screen menus and Status messages</b> ..	26
On-screen menus .....	26
Status messages .....	27

## Editing

<b>Editing titles/chapters</b> .....	28
Editing titles/chapters and playing chapters .....	28
Title operations .....	29
Chapter operations .....	29
<b>Creating, editing and playing play lists</b> .....	30
Creating play lists .....	30
Editing and playing play lists/chapters .....	31
Play list operations .....	31
Chapter operations .....	31
<b>Editing still pictures</b> .....	32
Picture and folder operation .....	32

## Transfer (Dubbing)

<b>Recording from a video cassette recorder</b> .....	33
Manual recording .....	33
DV automatic recording (DV AUTO REC) .....	33
<b>Transferring (dubbing) still pictures</b> .....	34
Transferring (dubbing) using the transferring (dubbing) list ..	34
Transferring (dubbing) all the still pictures of a card onto a DVD-RAM—COPY ALL PICTURES .....	35

## Convenient functions

<b>FUNCTIONS window</b> .....	35
<b>Disc and card management</b> .....	36
Setting the protection .....	36
Providing a disc with a name .....	36
Erasing all titles and play lists—Erase all titles .....	36
Erasing all the contents of a disc or card—Format .....	37
Enabling DVD-R to be played on other equipment—Finalize ..	37
<b>Entering text</b> .....	38
<b>Changing the unit's settings</b> .....	39
Common procedures .....	39
Summary of settings .....	39
Tuning .....	42
TV System .....	43
Clock settings .....	43
<b>Child Lock</b> .....	44

## Reference

<b>Maintenance/Disc and card handling</b> .....	44
<b>Specifications</b> .....	45
<b>Safety precautions</b> .....	45
<b>Glossary</b> .....	46
<b>Frequently asked questions</b> .....	47
<b>Error messages</b> .....	48
<b>Troubleshooting guide</b> .....	49
<b>Index</b> .....	Back cover

## Accessories



Please check and identify the supplied accessories.



1 Remote control (EUR7721KE0)



1 AC mains lead  
•For use with this unit only. Do not use it with other equipment.



1 RF coaxial cable

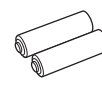

2 Batteries for remote control



1 Audio/video cable

## Useful features

This DVD Video recorder records high quality images to rapid random access capable DVD-RAM media. This has resulted in many new features that out perform older tape formats. The following information summarizes a few of these features.

### Instant recording

You no longer need to search for empty disc space. By pressing the recording button, the unit finds available recording space and begins recording right away. There is no need to worry about overwriting already recorded content.

### SD/PC card slots, DV input terminal

This unit is equipped with interfaces that allow networking with digital equipment.

- The SD/PC card slots of this unit let you transfer (dub) digital camera photographs from a card to DVD-RAM for easy storage without using a computer.
- The DV automatic recording function of this unit lets you easily transfer (dub) digital images to the DVD-RAM by connecting only a single DV cable.

### Instant play

There is no need to rewind or search forward. Direct Navigator guides you to the beginning of the recorded video immediately.



### Chasing playback

There is no need to wait until recording is complete. Without stopping recording, you can play the video currently being recorded from its beginning.



### Simultaneous Recording and Playback

While recording, you can play another video programme that was recorded previously.



### Time Slip

During play and also while recording, you can jump to the scene you wish to view by specifying the skip time.

## The remote control

### ■ Batteries

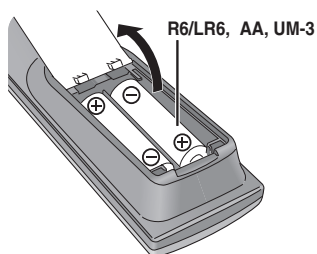

- Insert so the poles (+ and -) match those in the remote control.
- Do not use rechargeable type batteries.
- Do not mix old and new batteries.
- Do not use different types at the same time.
- Do not heat or expose to flame.
- Do not take apart or short circuit.
- Do not attempt to recharge alkaline or manganese batteries.
- Do not use batteries if the covering has been peeled off.

Mishandling of batteries can cause electrolyte leakage which can damage items the fluid contacts and may cause a fire.

Remove if the remote control is not going to be used for a long period of time. Store in a cool, dark place.

### Note

If you cannot operate the unit or television using the remote control after changing the batteries, please re-enter the codes (→ page 11).

### ■ Use

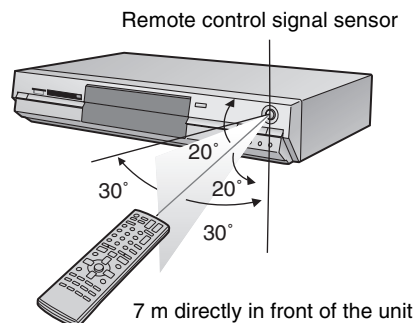

**The manufacturer accepts no responsibility and offers no compensation for loss of recorded or edited material due to a problem with the unit or recordable media, and accepts no responsibility and offers no compensation for any subsequent damage caused by such loss.**

### Examples of causes of such losses are

- A disc recorded and edited with this unit is played in a DVD recorder or computer disc drive manufactured by another company.
- A disc used as described above and then played again in this unit.
- A disc recorded and edited with a DVD recorder or computer disc drive manufactured by another company is played in this unit.

## Remote control

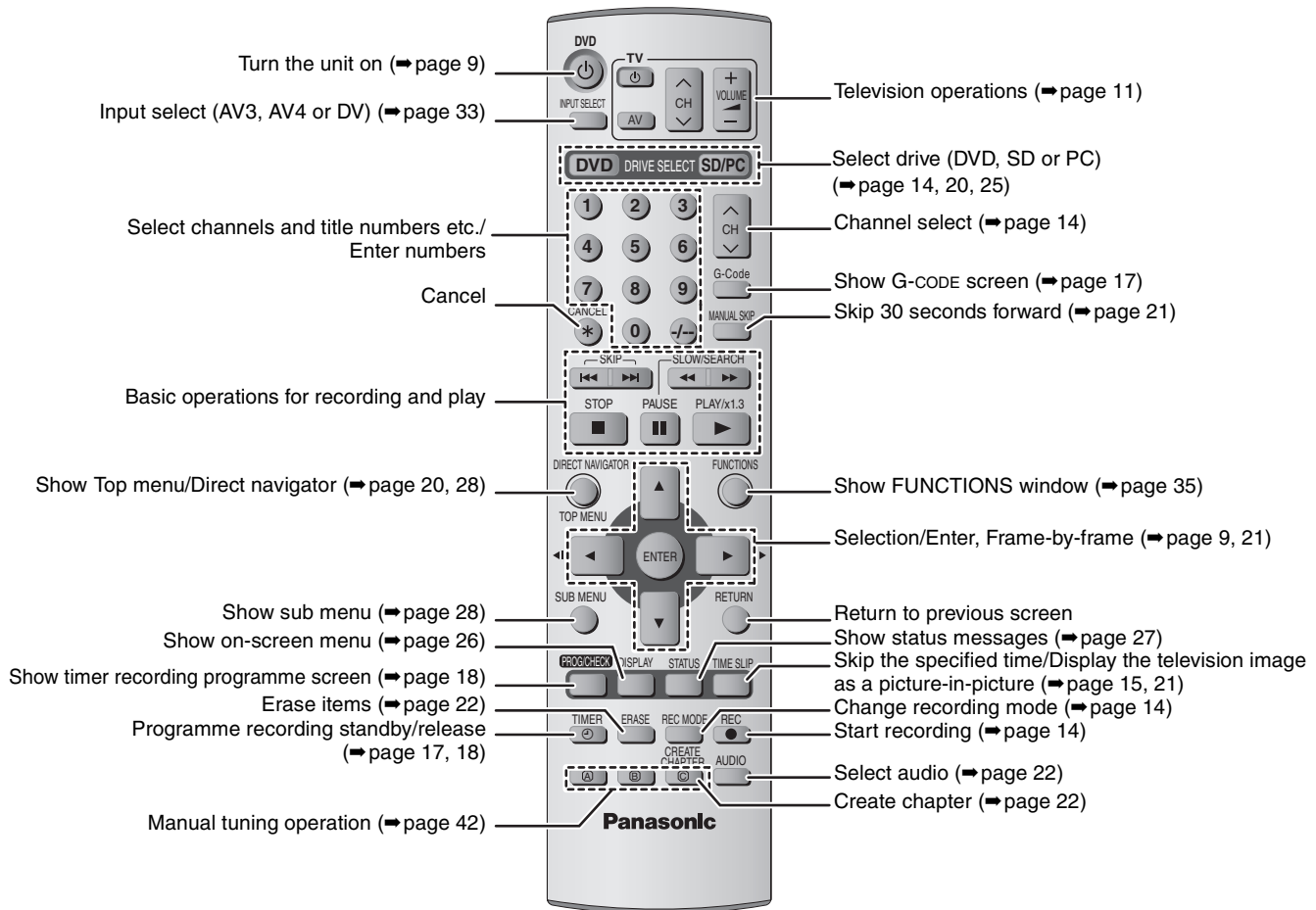

## Main unit

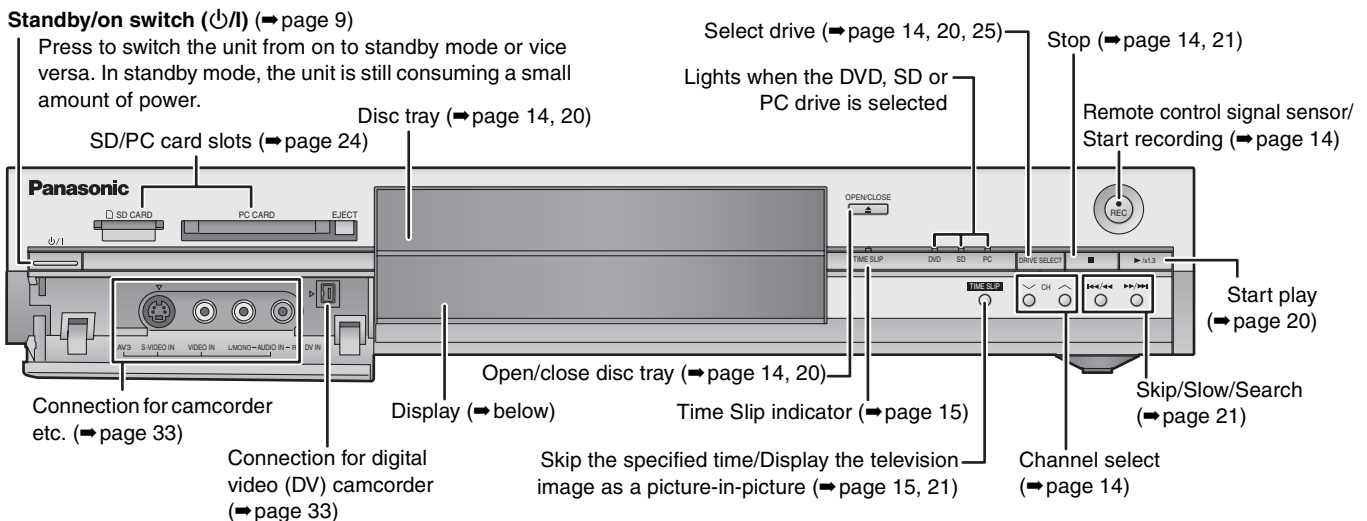

Rear panel terminals (⇒ page 7, 8)

## The unit's display

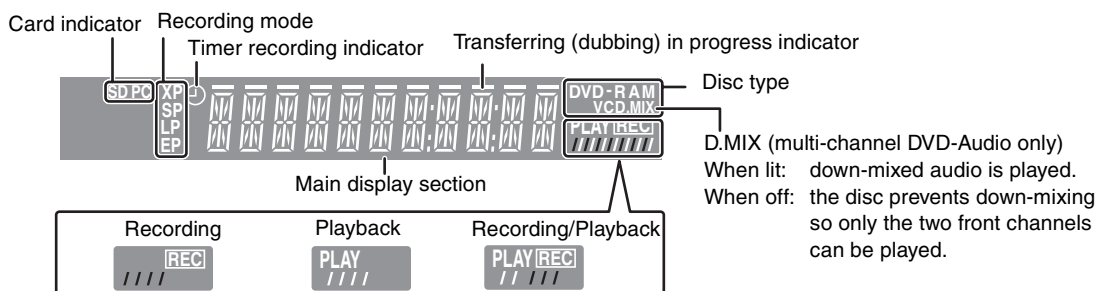

# STEP 1 Connection

- The equipment connections described are examples.
- Before connection, turn off all equipment and read the appropriate operating instructions.
- Peripheral equipment and optional cables sold separately unless otherwise indicated.

## ■ Examples of equipment you can connect to this unit's terminals

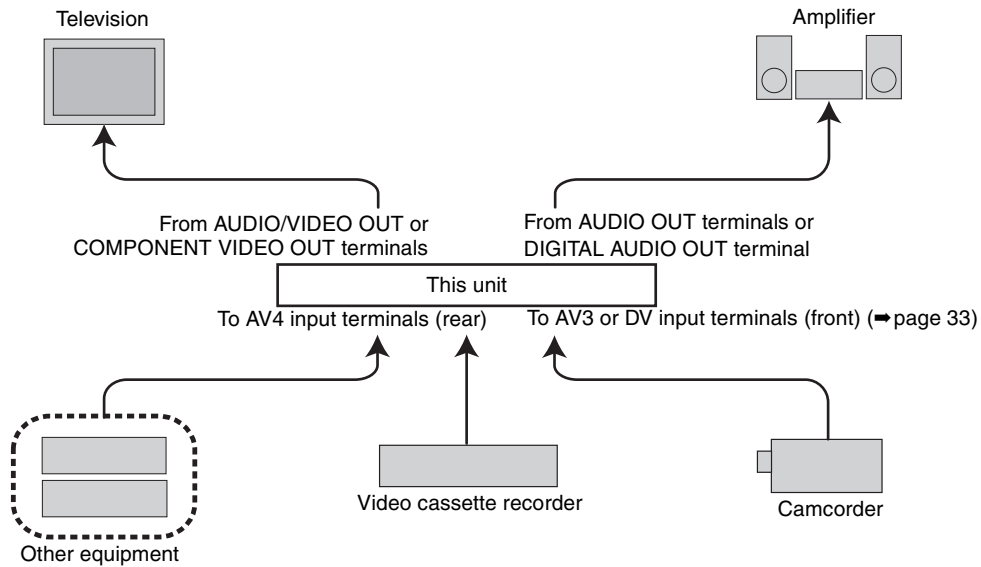

## ■ Do not connect the unit through a video cassette recorder

Video signals fed through video cassette recorders will be affected by copyright protection systems and the picture will not be shown correctly on the television.

- When connecting to a television with a built in VCR, connect to the input terminals on the television side, not the VCR side.

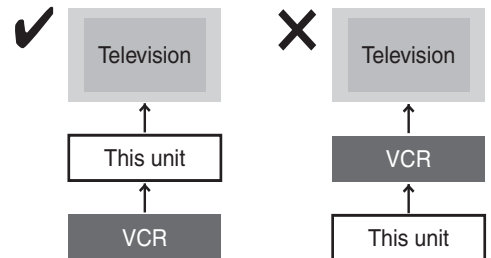

## ■ When the unit is not to be used for a long time

To save power, unplug it from the household mains socket. This unit consumes a small amount of power, even when it is turned off (approx. 3 W).

**Before moving the unit, ensure the disc tray is empty.**  
Failure to do so will risk severely damaging the disc and the unit.

# Connecting a television with AUDIO/VIDEO, S-VIDEO or COMPONENT VIDEO terminals and VCR

— indicates included accessories.

— indicates accessories not included.

① — ④ are required connections. Connect in the numbered order.

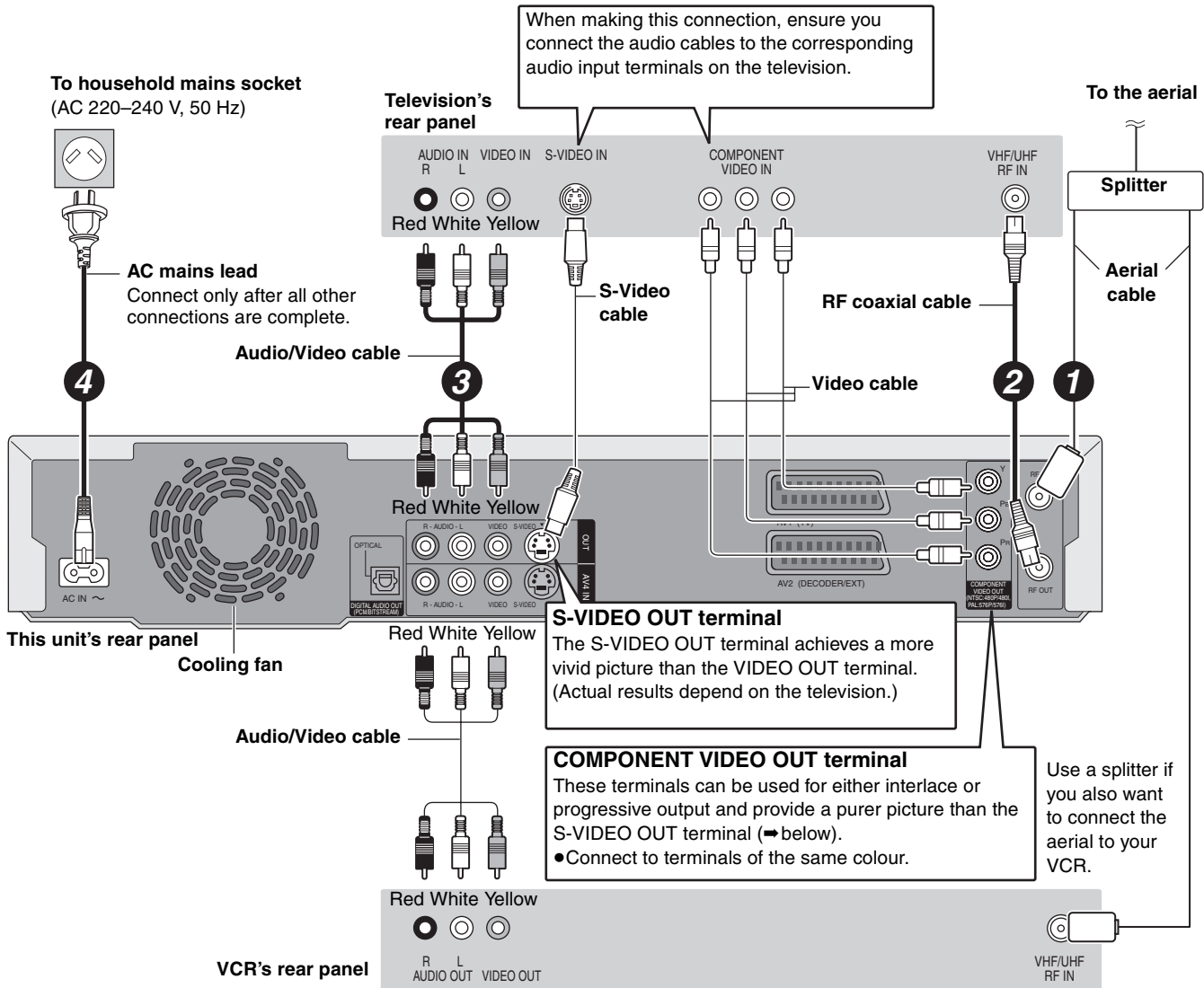

## ■ Component video output

Component signal outputs the colour difference signals (P<sub>B</sub>/P<sub>R</sub>) and luminance signal (Y) separately in order to achieve high fidelity in reproducing colours. If the television is compatible with progressive output, a high quality picture can be output because this unit's component video output terminal outputs a progressive output signal (→ page 46).

For progressive output (→ page 10)

## ■ Connecting to a television with 21-pin Scart terminal

You can also connect with the AV1 terminal on this unit using the 21-pin Scart cable.

If your television is equipped with RGB input capability, by connecting with a fully wired 21-pin Scart cable you can see video using RGB output on this unit.

To output in RGB select "RGB (without component)" from "AV1 Output" in the SETUP menu (→ page 41).

RGB refers to the three primary colours of light, red (R), green (G), and blue (B) and also the method of producing video that uses them. By dividing the video signal into the three colours for transmission, noise is reduced for even higher quality images.

## ■ Connecting to a VCR with 21-pin Scart terminal

You can also connect with the AV2 terminal on this unit using the 21-pin Scart cable.

To input in RGB select "RGB (Not NTSC)" from "AV2 Input" in the SETUP menu (→ page 41).

**STEP 1** Connection**Connecting an amplifier or system component****■ To enjoy multi-channel surround sound on DVD-Video**

Connect an amplifier with Dolby Digital, DTS and MPEG decoders using an optical digital audio cable and change the settings in "Digital Audio Output" (→ page 41) after tuning is completed (→ page 9).

- You cannot use DTS Digital Surround decoders not suited to DVD.
- Even if using this connection, output will be only 2 channels when playing DVD-Audio.

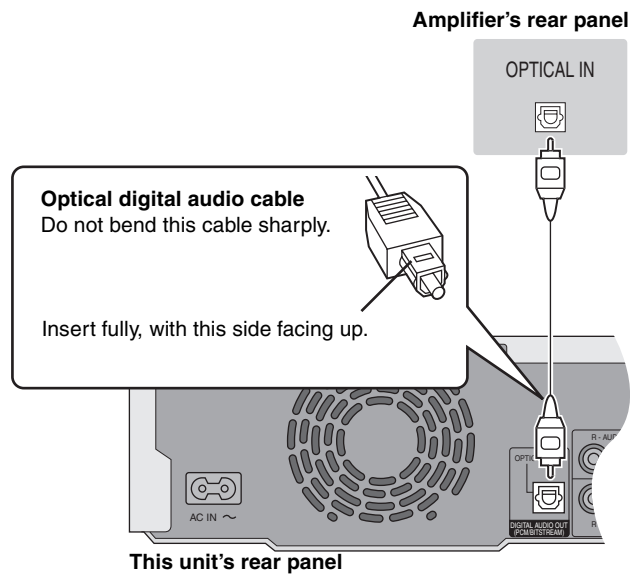
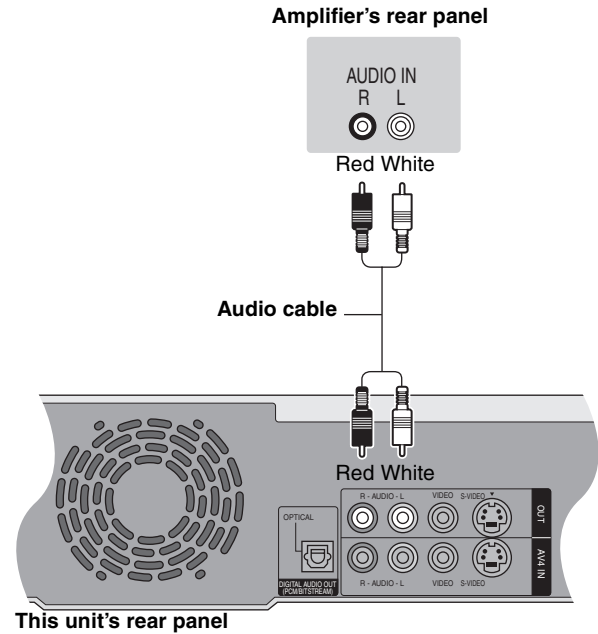
**■ Connection to a stereo amplifier**

**Do not place the unit on amplifiers or equipment that may become hot.**

The heat can damage the unit.

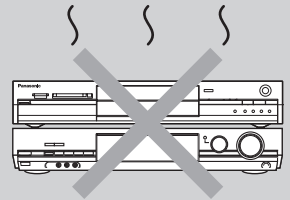



## STEP 2 Channel reception settings

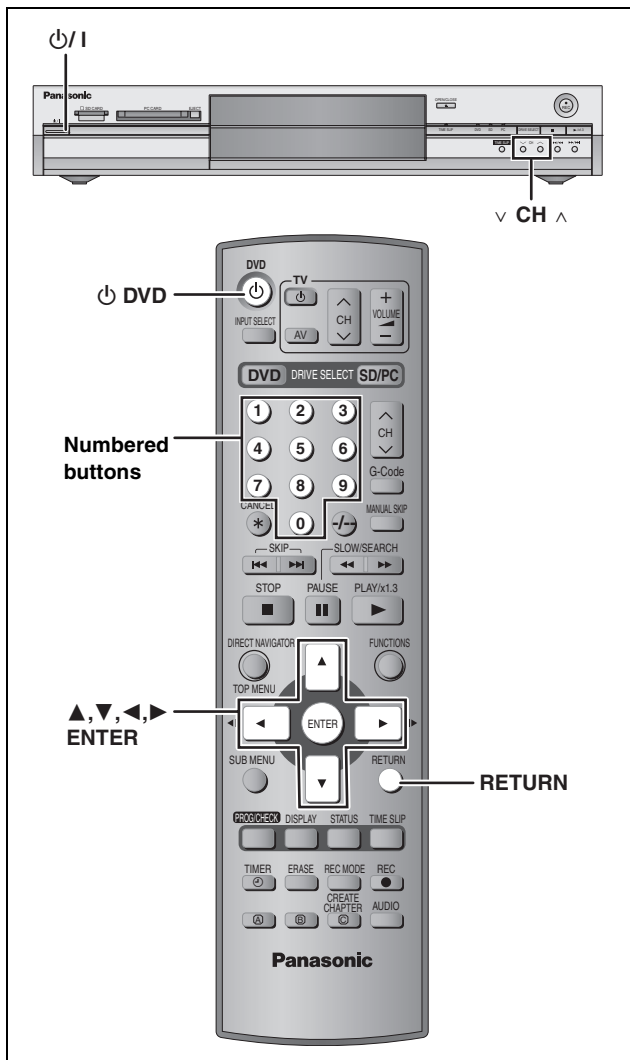

### Auto-Setup

When connecting to a television with the corresponding terminal (⇒ page 7).

This unit's Auto-Setup function automatically tunes all available TV stations.

- 1 Turn on the television and select the appropriate AV input to suit the connections to this unit.**
- 2 Press [DVD] to turn the unit on.**

The country setting menu appears on the television.

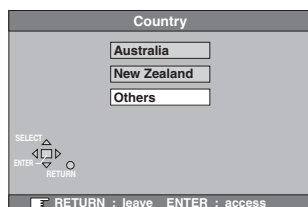

- 3 Press [▲, ▼] to select the country and press [ENTER].**

Auto-Setup starts. This takes about 5 minutes.

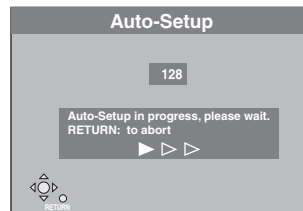

Auto-Setup is complete when you see the clock setting menu.

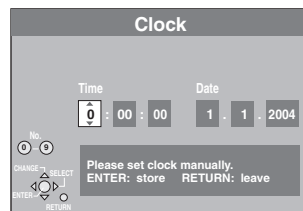

- 4 Press [◀, ▶] to select the item you want to change.**

This is a 24-hour clock.

The items change as follows:

Hour ↔ Minute ↔ Second ↔ Day ↔ Month ↔ Year

Reset the clock regularly to maintain accuracy (⇒ page 43).  
(Monthly accuracy +/- 15 seconds.)

- 5 Press [▲, ▼] to change the setting.**

You can also use the numbered buttons for setting.

- 6 Press [ENTER] when you have finished the settings.**

The clock starts and the television displays the channel being received.

### To stop partway

Press [RETURN].

- **To confirm that stations have been tuned correctly (⇒ page 42)**

- **To restart Auto-Setup (⇒ page 43)**

You can also use the following method to restart Auto-Setup.

When the unit is on and stopped

**Press and hold [▼ CH] and [CH ▲] on the main unit until the Country setting screen appears.**

- All the settings except for the ratings level, ratings password and time settings return to the factory preset. The timer recording programmes are also cancelled.

## STEP 3 Set up to match your television and remote control

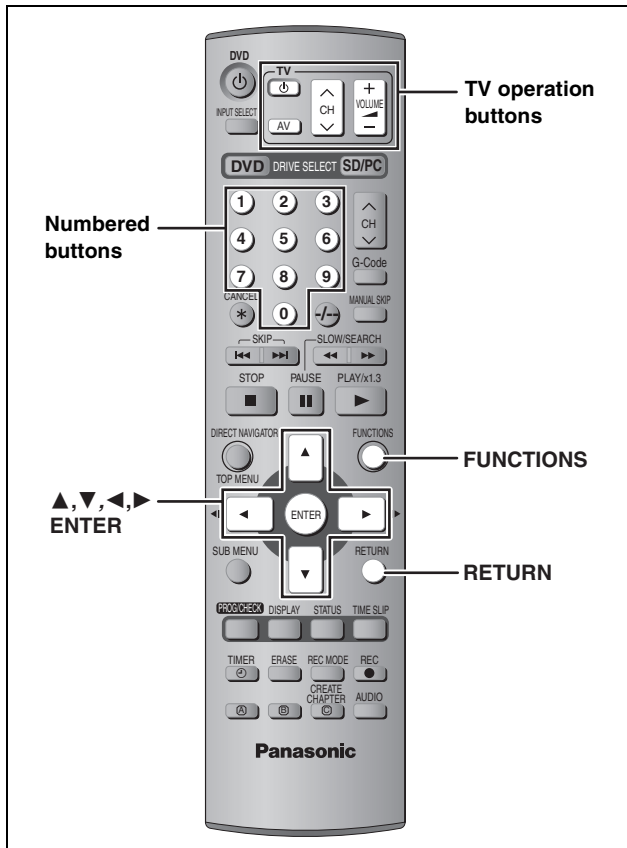

- 3 Press [**▲**, **▼**] to select “Connection” and press [**▶**].
- 4 Press [**▲**, **▼**] to select “TV Aspect” and press [**ENTER**].
- 5 Press [**▲**, **▼**] to select the TV aspect and press [**ENTER**].

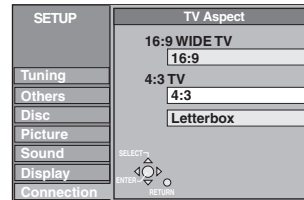

- **16:9**: 16:9 widescreen television
- **4:3**: 4:3 aspect television
- **RAM**: Titles are recorded as they appear on screen.
- **DVD-V**: Video recorded for a widescreen is played as Pan & Scan (unless prohibited by the producer of the disc) (⇒ page 46).
- **Letterbox**: 4:3 aspect television  
Widescreen picture is shown in the letterbox style (⇒ page 46).

### To enjoy progressive video

You can enjoy progressive video by connecting this unit's COMPONENT VIDEO OUT terminals to an LCD/plasma television or LCD projector compatible with progressive scan (⇒ page 46).

- 1 While stopped  
Press [**FUNCTIONS**].
- 2 Press [**▲**, **▼**, **◀**, **▶**] to select “SETUP” and press [**ENTER**].
- 3 Press [**▲**, **▼**] to select “Connection” and press [**▶**].
- 4 Press [**▲**, **▼**] to select “Progressive” and press [**ENTER**].
- 5 Press [**▲**, **▼**] to select “On” and press [**ENTER**].  
Output becomes progressive.

#### Note

- When connected to a regular television (CRT: Cathode ray tube) or a multi system television using PAL mode, even if it is progressive compatible, progressive output can cause some flickering. Turn off “Progressive” if this occurs (⇒ page 27).
- There is no output from the COMPONENT VIDEO OUT terminals if “AV1 Output” in the SETUP menu is set to “RGB (without component)”. Set this item to either “Video (with component)” or “S-Video (with component)” (⇒ page 41).
- If the unit is connected to the television through VIDEO OUT, S-VIDEO OUT or AV1 terminal, output will be interlace irrespective of the settings.

### Selecting television type and aspect

Choose the setting to suit your television and preference.

- 1 While stopped  
Press [**FUNCTIONS**].



- 2 Press [**▲**, **▼**, **◀**, **▶**] to select “SETUP” and press [**ENTER**].

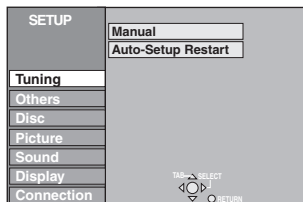

#### To exit the screen

Press [**RETURN**] several times.

#### To return to the previous screen

Press [**RETURN**].

## Television operation

You can configure the remote control TV operation buttons to turn the television on/off, change the television input mode, select the television channel and change the television volume.

Point the remote control at the television  
**While pressing [TV], enter the code with the numbered buttons.**

e.g., 01: [0] → [1]

### Manufacturer and Code No.

Brand	Code
Panasonic/National	01, 02, 03, 04
GOLDSTAR/LG	15, 16
HITACHI	08
JVC	07
mitsubishi	09, 10
NEC	13
PHILIPS	12
SAMSUNG	12, 17, 18
SANYO	14, 19
SHARP	11
SONY	05
TOSHIBA	06

Test by turning on the television and changing channels. Repeat the procedure until you find the code that allows correct operation.

- If your television brand is not listed or if the code listed for your television does not allow control of your television, this remote control is not compatible with your television.

## When other Panasonic products respond to this remote control

If other Panasonic products are placed close together, change the remote control code on the main unit and the remote control (the two must match).

Under normal circumstances use the factory set code “DVD 1”.

- 1** While stopped  
Press [FUNCTIONS].
- 2** Press [▲, ▼, ◀, ▶] to select “SETUP” and press [ENTER].
- 3** Press [▲, ▼] to select “Others” and press [▶].
- 4** Press [▲, ▼] to select “Remote Control” and press [ENTER].
- 5** Press [▲, ▼] to select the code (“DVD 1”, “DVD 2” or “DVD 3”) and press [ENTER].

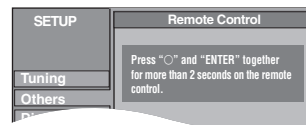

- 6** To change the code on the remote control  
While pressing [ENTER], press and hold the numbered button ([1], [2] or [3]) for more than 2 seconds.
- 7** Press [ENTER].

- When the following indicator appears on the unit's display





The unit's remote control code

Change the code on the remote control to match the main unit's (→ step 6).

### Note

Executing “Shipping Condition” in the SETUP menu returns the main unit code to “DVD 1”. Change the remote control code to 1 (→ step 6).

## Discs you can use for recording and play (12 cm/8 cm)

Disc type	Logo	Instructions
<b>DVD-RAM</b> ● 4.7 GB/9.4 GB, 12 cm ● 2.8 GB, 8 cm Indicated in these instructions with <b>RAM</b>		<b>Re-writable discs</b> <ul style="list-style-type: none"> <li>You can record up to 16 hours [in EP (8Hour) mode on double-sided disc. You cannot record or play continuously on two sides] (⇒ page 15, Recording modes and approximate recording times).</li> <li>You can view the title being recorded from the beginning (Chasing playback, Time Slip) (⇒ page 15).</li> <li>Scratch and dust resistant cartridge discs and large capacity double sided discs (9.4 GB) are commercially available.</li> <li>You can record digital broadcasts that allow “One time only recording” when using CPRM (Content Protection for Recordable Media) compatible discs (⇒ page 46).</li> <li>This unit is compatible with 1×–3× recording speed discs.</li> <li>You can play and transfer (dub) still pictures taken on a digital camera etc. (⇒ page 24, 34).</li> </ul>
<b>DVD-R</b> ● 4.7 GB, 12 cm ● 1.4 GB, 8 cm <b>DVD-R</b>		<b>One time recording discs (recordable until the disc is full)</b> <ul style="list-style-type: none"> <li>You can record up to 8 hours [in EP (8Hour) mode] (⇒ page 15, Recording modes and approximate recording times).</li> <li>By finalizing the disc, you can play it in a DVD player as DVD-Video (Play only) (⇒ page 37, 46).</li> <li>You cannot record digital broadcasts that allow “One time only recording”.</li> <li>This unit is compatible with 1×–4× recording speed discs.</li> </ul>

- We recommend using Panasonic discs. DVD-R from other manufacturers may not be recorded or played due to the condition of the recording.
- This unit cannot record to discs containing both PAL and NTSC signals. Play of discs recorded with both PAL and NTSC on another unit is not guaranteed.





### Which should I use, DVD-RAM or DVD-R?

The following chart indicates the differences. Select based upon what you require.

(√: Possible, X: Impossible)	DVD-RAM	DVD-R
Re-writable	√	X
Edit	√	※1
Play on other players	√※2	√※3
Recording both M 1 and M 2 of bilingual broadcast	√	X※4
Recording broadcasts that allow one copy	√※5	X
Recording 16:9 aspect picture	√	※6

- ※ 1 You can erase, enter name and change thumbnail. Available space does not increase after erasing.
- ※ 2 Only on DVD-RAM compatible players.
- ※ 3 After finalizing the disc (⇒ page 37, 46).
- ※ 4 Only one is recorded (⇒ page 41, Bilingual Audio Selection).
- ※ 5 CPRM (⇒ page 46) compatible discs only.
- ※ 6 The picture is recorded in 4:3 aspect.

## Play-only discs (12 cm/8 cm)

Disc type	Logo	Instructions
<b>DVD-Audio</b> <b>DVD-A</b>		High fidelity music discs <ul style="list-style-type: none"> <li>Played on this unit in 2 channels.</li> </ul>
<b>DVD-Video</b> <b>DVD-V</b>		High quality movie and music discs
<b>Video CD</b> <b>VCD</b>		Recorded music and video (including CD-R/RW)
<b>Audio CD</b> <b>CD</b>		Recorded music and audio (including CD-R/RW)
	—	CD-R and CD-RW with music recorded in MP3 (⇒ page 23)

- This unit plays CD-R/CD-RW discs (audio recording discs) which have been recorded under one of the following standards: CD-DA, MP3 and Video CD. Close the session or finalize the disc after recording.

Play may be impossible on some CD-R or CD-RW discs due to the condition of the recording.

- The producer of the material can control how discs are played. So you may not always be able to control play as described in these operating instructions. Read the disc's instructions carefully.

## Discs that cannot be played

- 2.6 and 5.2 GB DVD-RAM, 12 cm
  - 3.95 and 4.7 GB DVD-R for Authoring
  - Unfinalized DVD-R recorded on other equipment (⇒ page 46, Finalize)
  - DVD-Video with a region number other than “4” or “ALL”
- |           |                         |        |            |
|-----------|-------------------------|--------|------------|
| ● DVD-ROM | ● DVD-RW                | ● +R   | ● +RW      |
| ● CD-ROM  | ● CDV                   | ● CD-G | ● Photo CD |
| ● CVD     | ● SVCD                  | ● SACD | ● MV-Disc  |
| ● PD      | ● Divx Video Disc, etc. |        |            |

## Cards useable on this unit

Type	Instructions
<b>SD Memory Card</b> <b>MultiMediaCard</b> <b>SD</b>	You can insert directly into the SD card slot. <ul style="list-style-type: none"> <li>You can play and transfer (dub) still pictures taken on a digital camera etc. (⇒ page 24, 34).</li> <li>You can set the DPOF (Digital Print Order Format) for automatic printing on your home printer or at a photo developing store (⇒ page 32, 46).</li> </ul>
<b>SD Memory Card</b> <b>MultiMediaCard</b> <b>CompactFlash</b> <b>SmartMedia</b> <b>MEMORYSTICK</b> <b>xD-Picture Card</b> <b>Microdrive</b> <b>PC</b>	You can insert into the PC card slot using an adaptor (TYPE II PC card adaptor). <ul style="list-style-type: none"> <li><b>Compatible with:</b> FAT 12 or FAT 16</li> <li>We recommend using a Panasonic SD card.</li> <li>You cannot use SD cards that exceed 2 GB.</li> <li>We recommend using this unit to format a card before recording (⇒ page 37, 46).</li> <li>You may not be able to use the card if formatted on a computer.</li> </ul>
<b>ATA Flash PC Card</b> <b>Mobile hard disk*</b> <b>PC</b>	You can insert directly into the PC card slot. <ul style="list-style-type: none"> <li>* Content saved on SD media storage (SV-PT1). You can only play the recorded still pictures and transfer (dub) the data onto other cards or DVD-RAM.</li> </ul>

### Structure of folders displayed by this unit

The following  can be displayed on this unit.

\*\*\*: Numbers      XXX: Letters

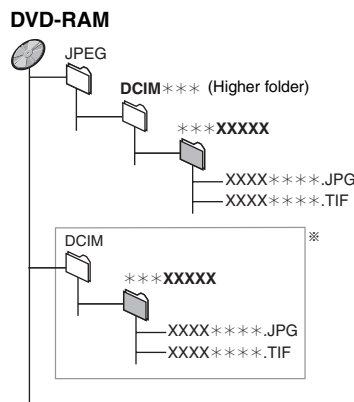
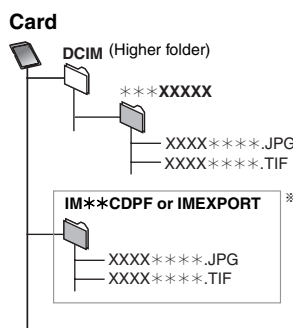

\* Folders can be created on other equipment. However, these folders cannot be selected as a transferring (dubbing) destination.

• The folder cannot be displayed if the numbers are all "0" (e.g., DCIM000 etc).

• If a folder name or filename has been input using other equipment, the name may not be displayed properly or you may not be able to play or edit the data.

## Types of disc for the type of connected TV

When you use the discs recorded either PAL or NTSC, refer to this table.

(√: Possible, X: Impossible)

TV type	Disc	Yes/No
Multi-system TV	PAL	√
	NTSC	√ <sup>#1</sup>
NTSC TV	PAL	X
	NTSC	√ <sup>#2</sup>
PAL TV	PAL	√
	NTSC	√ <sup>#3</sup> (PAL60)

<sup>#1</sup> If you select "NTSC" in "TV System" (⇒ page 43), the picture may be clearer.

<sup>#2</sup> Select "NTSC" in "TV System" (⇒ page 43).

<sup>#3</sup> If your television is not equipped to handle PAL 525/60 signals the picture will not be shown correctly.

### Accessory discs

#### DVD-RAM

9.4 GB, double-sided, type 4 cartridge: LM-AD240LE

4.7 GB, single-sided, type 2 cartridge: LM-AB120LE

4.7 GB, single-sided, non-cartridge: LM-AF120LE

#### DVD-R

4.7 GB, single-sided, non-cartridge: LM-RF120LE

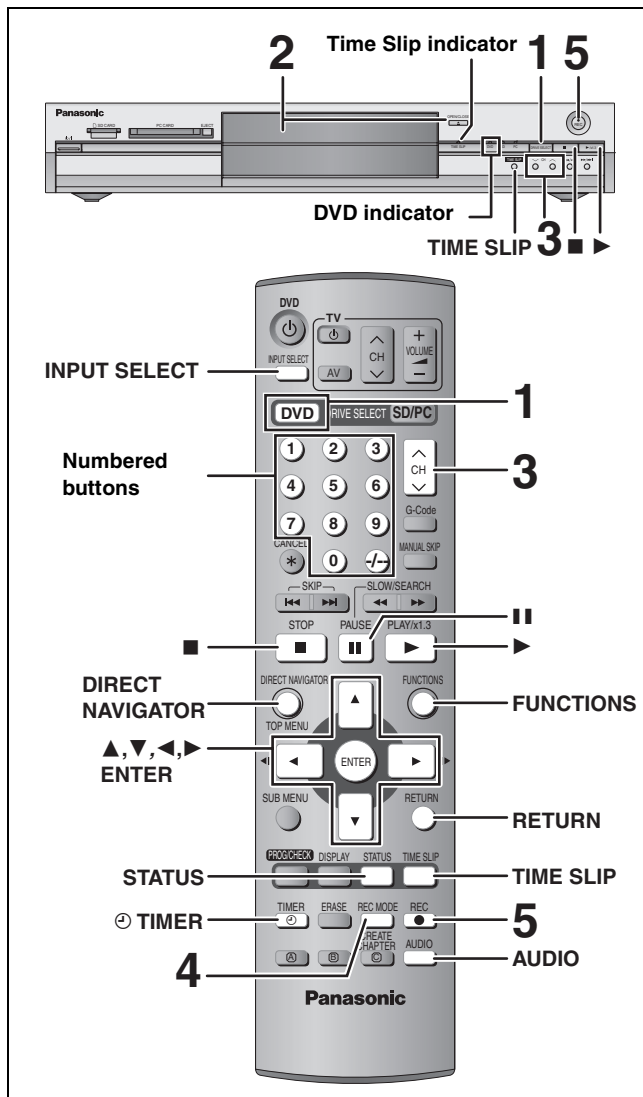

### RAM DVD-R

- You can record up to 99 titles on one disc.
- It is not possible to record continuously from one side of a double sided disc to the other. You will need to eject the disc and turn it over.
- When using 8 cm DVD-RAM, remove the disc from the cartridge.
- It is not possible to record CPRM (⇒ page 46) protected material onto DVD-R or 2.8 GB DVD-RAM discs.
- It is not possible to record to a card.

### When recording to DVD-R

- When recording bilingual broadcasts, only the audio selected in “Bilingual Audio Selection” (⇒ page 41) is recorded (“M 1” or “M 2”).
- In order to play a DVD-R recorded using this unit on another playback source, the disc must first be finalized (⇒ page 37).

- 1 Press [DVD] to select the DVD drive.  
The DVD indicator lights up on the unit.
- 2 Press [▲ OPEN/CLOSE] on the main unit to open the tray and insert a disc.  
• Press the button again to close the tray.  
Insert label-up. Insert fully so it clicks into place.

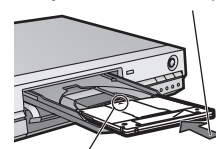
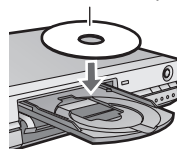

Insert with the arrow facing in.

- 3 Press [▲ ▼ CH] to select the channel.



To select with the numbered buttons:

e.g., 5: [0] ⇒ [5]

15: [-/-] ⇒ [1] ⇒ [5]

- 4 Press [REC MODE] to select the recording mode (XP, SP, LP or EP).



Remaining time on the disc

- To record sound using LPCM (XP mode only):  
Set the “Audio Mode for XP Recording” to “LPCM” in the SETUP menu (⇒ page 41).

- 5 Press [● REC] to start recording.



Recording will take place on open space on disc. Data will not be overwritten.

- You cannot change the channel or recording mode during recording.
- **RAM** You can change the audio being received by pressing [AUDIO] during recording. (Does not affect the recording of audio.)

### ■ To stop recording

Press [■].

From the start to the end of the recording is called one title.

### DVD-R

It takes about 30 seconds for the unit to complete recording management information after recording finishes.

### ■ To pause recording

Press [II].

Press again to restart recording.

(Title is not split into separate titles.)

## ■ To specify a time to stop recording—One Touch Recording

### During recording

Press [● REC] on the main unit to select the recording time.

Each time you press the button:

30 (min.) → 60 (min.) → 90 (min.) → 120 (min.)  
 ↶ Counter (cancel) ← 240 (min.) ← 180 (min.) ↷

- This does not work during timer recordings (⇒ page 17) or while using Flexible Recording (⇒ page 16).

### To stop recording partway

Press [■].

## Recording modes and approximate recording times

Depending on the content being recorded, the recording times may become shorter than indicated.

(Unit: hour)

Mode	DVD-RAM		DVD-R (4.7 GB)
	Single-sided (4.7 GB)	Double-sided (9.4 GB)	
XP (High quality)	1	2	1
SP (Normal)	2	4	2
LP (Long play)	4	8	4
EP (Extra long play)	8 (6*)	16 (12*)	8 (6*)

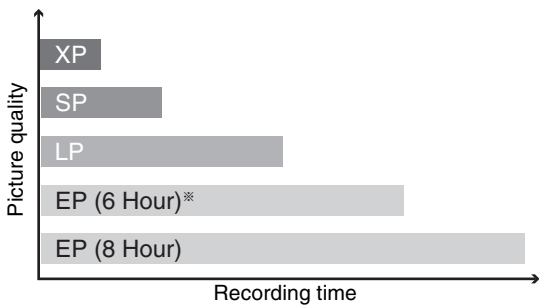

\* When "Recording time in EP mode" is set to "EP (6Hour)" in the SETUP menu.

The sound quality is better when using "EP (6Hour)" than when using "EP (8Hour)".

### Note

When recording to DVD-RAM using "EP (8Hour)" mode, play may not be possible on DVD players that are compatible with DVD-RAM. In this case use "EP (6Hour)" mode.

### FR (Flexible Recording Mode)

The unit automatically selects a recording rate between XP and EP (8Hour) that will enable the recordings to fit in the remaining disc space with the best possible recording quality.

- You can set when programming timer recordings.
- All the recording modes from XP to EP appear in the display.



## Playing while you are recording

While recording to DVD-RAM you can view the title being recorded from the beginning as well as play a recorded title.

### RAM

### Playing from the beginning of the title you are recording—Chasing playback

#### Press [▶] (PLAY).

Time Slip indicator on the main unit lights.

### Playing a title previously recorded while recording—Simultaneous rec and play

#### 1 Press [DIRECT NAVIGATOR].

#### 2 Press [▲, ▼, ◀, ▶] to select a title and press [ENTER].

Time Slip indicator on the main unit lights.

### To exit the DIRECT NAVIGATOR screen

Press [DIRECT NAVIGATOR].

### Reviewing the recorded images while recording—Time Slip

#### 1 Press [TIME SLIP].

Time Slip indicator on the main unit lights.

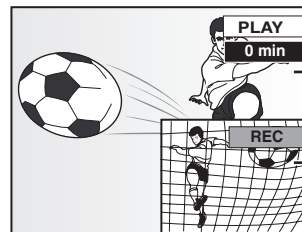

Play starts from 30 seconds previous.

The image currently being recorded

- You will hear the playback audio.

#### 2 Press [▲, ▼] to select the time and press [ENTER].

- Press [TIME SLIP] to show the play images in full. Press again to show the play and recording images.

### ■ To stop play

Press [■].

### ■ To stop recording

2 seconds after play stops

Press [■].

### ■ To stop timer recording

Press [⊙ TIMER].

- You can also press and hold [■] on the main unit for more than 3 seconds to stop recording.

Refer to the control reference on page 14.

RAM DVD-R

## Flexible Recording

The unit sets the best possible picture quality that fits the recording within the remaining disc space. The recording mode becomes FR mode.

e.g.,

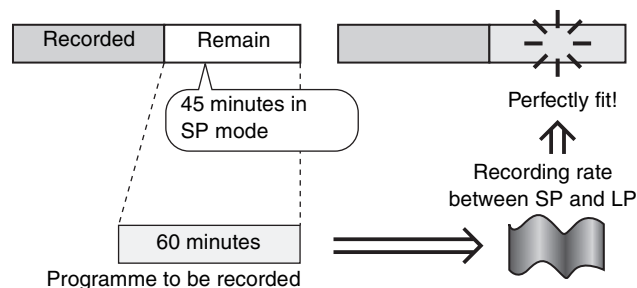

### Preparation

Select the channel to record.

- 1 While stopped  
Press [FUNCTIONS].
- 2 Press [▲, ▼, ◀, ▶] to select  
“FLEXIBLE REC” and press [ENTER].

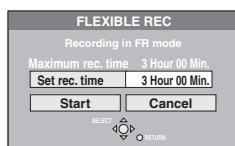

- 3 Press [◀, ▶] to select “Hour” and  
“Min.” and press [▲, ▼] to set the  
recording time.  
• You can also set the recording time with the numbered  
buttons.
- 4 When you want to start recording  
Press [▲, ▼, ◀, ▶] to select “Start”  
and press [ENTER].  
Recording starts.

### To exit the screen without recording

Press [RETURN].

### To stop recording partway

Press [■].

### To show the remaining time

Press [STATUS].





# Timer recording

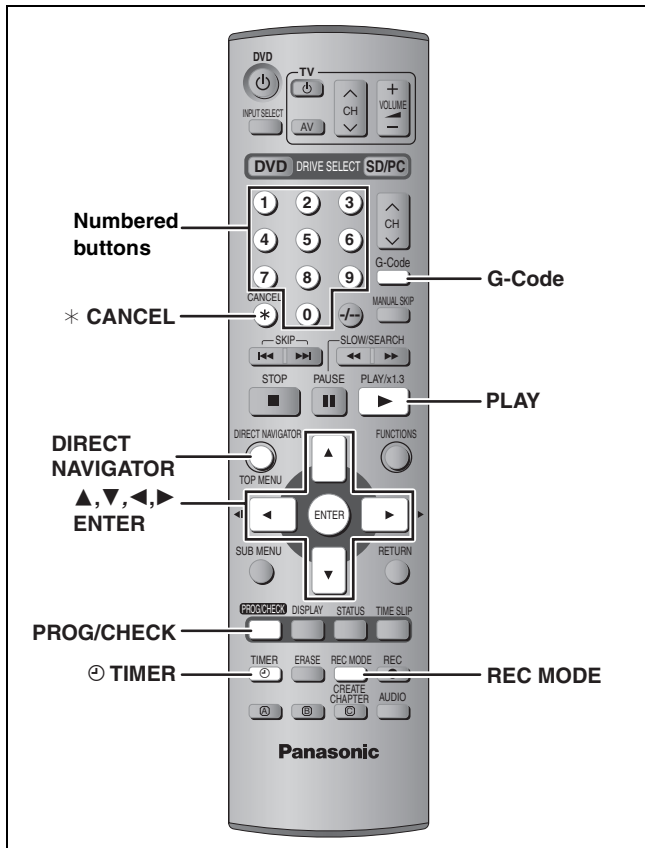

## RAM DVD-R

You can enter up to 16 programmes up to a month in advance.

## Using G-CODE® system to make timer recordings

Entering G-CODE numbers is an easy way of timer recording. You can find these numbers in TV listings in newspapers and magazines.

### 1 Press [G-Code].

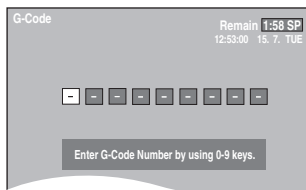

### 2 Press the numbered buttons to enter the G-CODE number.

Press [◀] to move back to correct a digit.

### 3 Press [ENTER].

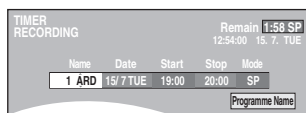

- Confirm the programme and make corrections if necessary using [▲, ▼, ◀, ▶] (⇒ page 18, step 3).
- When “- - -” appears in the “Name” column, you cannot set timer recording. Press [▲, ▼] to select desired programme position. After you have entered the information of a TV station, it is kept in the unit’s memory.
- You can also press [REC MODE] to change the recording mode.
- **Programme Name**  
Press [◀, ▶] to select “Programme Name” and press [ENTER] (⇒ page 38).

### 4 Press [ENTER].

The settings are stored.

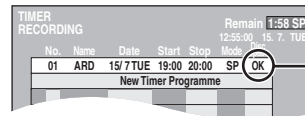

Check to make sure “OK” is displayed (⇒ page 19).

Repeat steps 1–4 to programme other recordings.

### 5 Press [⊙ TIMER].

The unit turns off and “⊙” lights on the unit’s display to indicate timer recording standby has been activated.

## RAM

Even if the unit is in timer recording standby, play starts when you press [▶] (PLAY) or [DIRECT NAVIGATOR]. Timer recording works even during play.

### ■ To release the unit from recording standby

#### Press [⊙ TIMER].

The unit turns on and “⊙” goes out.

- Be sure to press [⊙ TIMER] before the programme start time to put the unit on recording standby. Timer recording will work only if “⊙” is displayed.

### ■ To cancel recording when recording has already begun

#### Press [⊙ TIMER].

- You can also press and hold [■] on the main unit for more than 3 seconds to stop recording.

## Note

- “⊙” flashes for about 5 seconds when the unit cannot go to timer recording standby (e.g., a recordable disc is not in the disc tray).
- If the unit is not put in the timer recording standby mode at the latest 10 minutes before the programmed timer recording starting time, the “⊙” flashes on the unit display. In this case, press [⊙ TIMER] to put the unit in the timer recording standby mode.
- When you programme successive timer recordings to start immediately one after the other, the unit cannot record the part at the beginning of the later programmes (a few seconds when recording with DVD-RAM and approximately 30 seconds when recording with DVD-R).

Refer to the control reference on page 17.

**RAM DVD-R**

You can enter up to 16 programmes up to a month in advance. (Each daily or weekly programme is counted as one programme.)

**Manually programming timer recordings**

**1 Press [PROG/CHECK].**

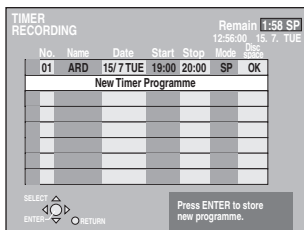

**2 Press [▲, ▼] to select “New Timer Programme” and press [ENTER].**

**3 Press [▶] to move through the items and change the items with [▲, ▼].**

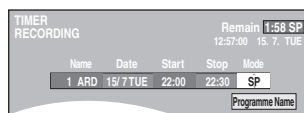

- Press and hold [▲, ▼] to alter the Start (Start time) and Stop (Finish time) in 30-minute increments.
- You can also set Name (Programme position/TV Station Name), Date, Start (Start time), and Stop (Finish time) with the numbered buttons.
- You can also press [REC MODE] to change the recording mode.

**•Date**

- Date: Current date up to one month later minus one day
- ↓ ↑
- Daily timer: SUN-SAT → MON-SAT → MON-FRI
- ↓ ↑
- Weekly timer: SUN → --- → SAT

**•Programme Name**

Press [◀, ▶] to select “Programme Name” and press [ENTER] (→ page 38).

**4 Press [ENTER].**

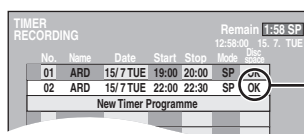

Check to make sure “OK” is displayed (→ page 19).

Repeat steps 2–4 to programme other recordings.

**5 Press [⏻ TIMER].**

The unit turns off and “⏻” lights on the unit’s display to indicate timer recording standby has been activated.

**RAM**

Even if the unit is in timer recording standby, play starts when you press [▶] (PLAY) or [DIRECT NAVIGATOR]. Timer recording works even during play.

**■ To release the unit from recording standby**

Press [⏻ TIMER].

The unit turns on and “⏻” goes out.

- Be sure to press [⏻ TIMER] before the programme start time to put the unit on recording standby. Timer recording will work only if “⏻” is displayed.

**■ To cancel recording when recording has already begun**

Press [⏻ TIMER].

- You can also press and hold [■] on the main unit for more than 3 seconds to stop recording.

**Note**

- “⏻” flashes for about 5 seconds when the unit cannot go to timer recording standby (e.g., a recordable disc is not in the disc tray).
- If the unit is not put in the timer recording standby mode at the latest 10 minutes before the programmed timer recording starting time, the “⏻” flashes on the unit display. In this case, press [⏻ TIMER] to put the unit in the timer recording standby mode.
- When you programme successive timer recordings to start immediately one after the other, the unit cannot record the part at the beginning of the later programmes (a few seconds when recording with DVD-RAM and approximately 30 seconds when recording with DVD-R).

## Check, change or delete a programme

- Even when the unit is turned off, you can display the timer recording list by pressing [PROG/CHECK].

### Press [PROG/CHECK].

#### Icons

- This programme is currently recording.
- Ⓜ The times overlap those in another programme. Recording of the programme with the later start time starts when the earlier programme finishes recording.
- Ⓣ The disc was full so the programme failed to record.
- Ⓛ The material was copy-protected so it was not recorded.
- ⓧ The programme did not complete recording because the disc is dirty or some other reason.

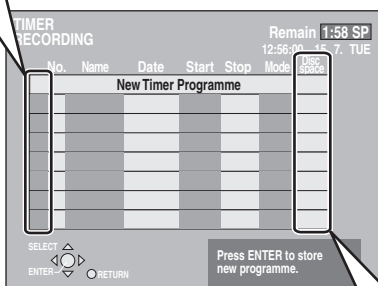

#### Message displayed in the “Disc space” line

- OK:** Displayed if the recording can fit in the remaining space.
- **(Date):** For recordings made daily or weekly, the display will show until when recordings can be made (up to a maximum of one month from the present time) based on the time remaining on the disc.
- ! :** It may not be possible to record because:
  - there is not enough space left
  - the number of possible titles has reached its maximum.

#### ■ To change a programme

Press [▲, ▼] to select the programme and press [ENTER].  
(→ page 18, step 3)

#### ■ To delete a programme

Press [▲, ▼] to select the programme and press [\* CANCEL].

#### ■ To exit the timer recording list

Press [PROG/CHECK].

#### ■ To put the unit on timer recording standby

Press [⏻ TIMER].

The unit turns off and “⏻” lights on the unit’s display to indicate timer recording standby has been activated.

- Programmes that failed to record are deleted from the timer recording list at 4 a.m. two days later.

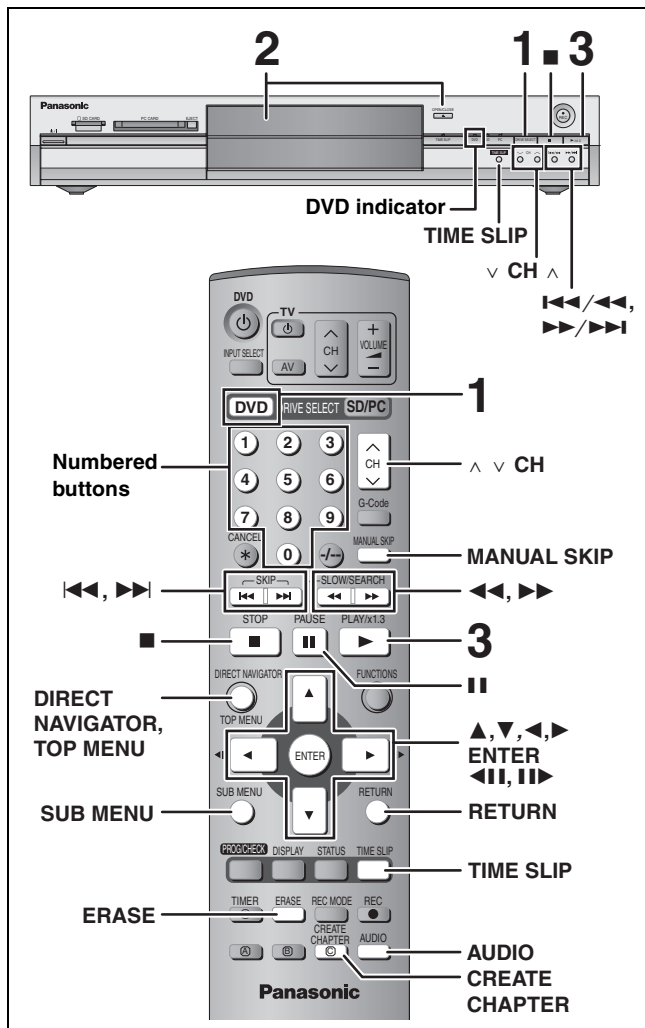

- It is not possible to play continuously from one side of a double sided disc to the other. You will need to eject the disc and turn it over.
- When using 8 cm DVD-RAM, remove the disc from the cartridge.

- 1 Press [DVD] to select the DVD drive.**  
The DVD indicator lights up on the unit.
- 2 Press [▲ OPEN/CLOSE] on the main unit to open the tray and insert a disc.**  
• Press the button again to close the tray.

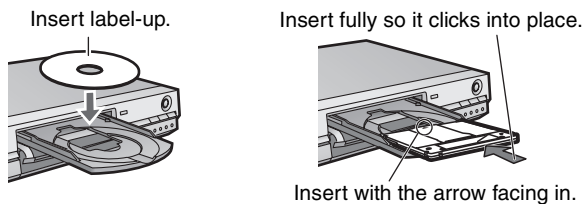

- 3 Press [▶] (PLAY).**

**RAM DVD-R**

Play starts from the most recently recorded title.

**DVD-A DVD-V VCD CD**

Play starts from the beginning of the disc.



## ■ Selecting recorded programmes (titles) to play— Direct Navigator

**RAM DVD-R**

- 1 Press [DIRECT NAVIGATOR].**

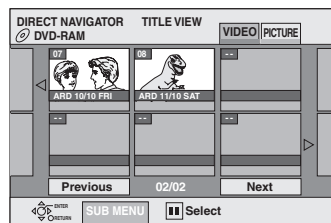

- 2 Press [▲, ▼, ◀, ▶] to select “VIDEO” tab and press [ENTER].**

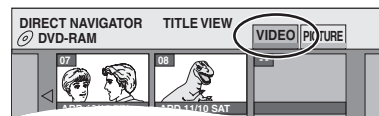

- 3 Press [▲, ▼, ◀, ▶] to select the title and press [ENTER].**

You can also select titles with the numbered buttons.

e.g., 5: [0] ⇒ [5]  
15: [1] ⇒ [5]

### To show other pages

Press [▲, ▼, ◀, ▶] to select “Previous” or “Next” and press [ENTER].

- You can also press [◀◀, ▶▶] to show other pages.

### To exit the screen

Press [DIRECT NAVIGATOR].

### Direct Navigator screen icons

	Title protected.
	Title that was not recorded due to recording protection (Digital broadcasts etc.)
	Title cannot be played because data is damaged etc.
	Currently recording.
	Title recorded using a different encoding system from that of the TV system currently selected on the unit.
	Title recorded using a different encoding system from that of the TV system currently selected on the unit. • Alter the “TV System” setting on this unit to suit (⇒ page 43).

## ■ When a menu screen appears on the television

**DVD-A DVD-V**

Press [▲, ▼, ◀, ▶] to select the item and press [ENTER].

Some items can also be selected using the numbered buttons.

**VCD**

Press the numbered buttons to select the item.

e.g., 5: [0] ⇒ [5]  
15: [1] ⇒ [5]



### • To return to the menu screen

**DVD-A** Press [TOP MENU].

**DVD-V** Press [TOP MENU] or [SUB MENU].

**VCD** Press [RETURN].

## Operations during play

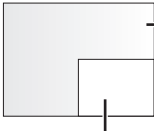
<p>Stop</p>	<p><b>Press [■].</b>            The stopped position is memorized.            The indicator on the right appears in the unit's display. (Excluding when playing from the Direct Navigator and when playing a play list.)  <b>Resume play function</b>            Press [▶] (PLAY) to restart from this position.</p> 
<p>Pause</p>	<p><b>Press [⏸].</b>            Press again to restart play.</p>
<p>Search</p>	<p><b>Press [◀◀] or [▶▶].</b></p> <ul style="list-style-type: none"> <li>On the main unit, press and hold [◀◀/◀◀] or [▶▶/▶▶].</li> <li>The speed increases up to 5 steps.</li> <li>Press [▶] (PLAY) to restart play.</li> <li>Audio is heard during first level search forward.            You can turn off the sound during search (→ page 41, "PLAY ×1.3 &amp; Audio during Search").            Audio is heard during all levels of search. <b>DVD-A</b> (excluding moving picture parts) <b>CD</b></li> </ul>
<p>Skip</p>	<p><b>Press [◀◀] or [▶▶].</b></p> <ul style="list-style-type: none"> <li>On the main unit, press [◀◀/◀◀] or [▶▶/▶▶].</li> <li>Each press increases the number of skips.</li> </ul>
<p>Starting from a selected item</p>	<p><b>Press the numbered buttons.</b></p> <p>e.g., 5: [0] → [5] <b>CD</b> (MP3 discs only) 5: [0] → [0] → [5]            15: [1] → [5] 15: [0] → [1] → [5]</p> <p><b>DVD-A</b> Selecting groups            While stopped (screen saver is displayed on the television → right)            5: [5]</p>  <ul style="list-style-type: none"> <li>This works only when stopped (screen saver is displayed on the television → right) with some discs.</li> </ul>
<p>Quick View  <b>RAM</b>            The play speed can be increased without distorting the audio.</p>	<p><b>Press and hold [▶] (PLAY/×1.3).</b></p> <ul style="list-style-type: none"> <li>Press again to return to normal speed.</li> <li>This does not work if the setting is "Off" in "PLAY ×1.3 &amp; Audio during Search" (→ page 41).</li> </ul>
<p>Slow-motion  <b>RAM DVD-R DVD-A</b> (Motion picture parts only) <b>DVD-V VCD</b></p>	<p><b>While paused, press [◀◀] or [▶▶].</b></p> <ul style="list-style-type: none"> <li>On the main unit, press and hold [◀◀/◀◀] or [▶▶/▶▶].</li> <li>The speed increases up to 5 steps.</li> <li>Press [▶] (PLAY) to restart play.</li> <li>Forward direction only. <b>VCD</b></li> <li>The unit will pause if slow-motion play is continued for 5 minutes.</li> </ul>
<p>Frame-by-frame  <b>RAM DVD-R DVD-A</b> (Motion picture parts only) <b>DVD-V VCD</b></p>	<p><b>While paused, press [◀◀] or [▶▶].</b></p> <ul style="list-style-type: none"> <li>Each press shows the next frame.</li> <li>Press [▶] (PLAY) to restart play.</li> <li>Forward direction only. <b>VCD</b></li> </ul>
<p>Displaying the television image as a picture-in-picture</p>	<p><b>Press [TIME SLIP].</b>            The unit displays the television image as a picture-in-picture.</p> <ul style="list-style-type: none"> <li>You will hear the playback audio.</li> <li>Press [TIME SLIP] again to cancel.</li> <li>Time Slip does not work when the unit's "TV System" settings are different from the title recorded on the disc.</li> <li>The grey background does not appear on the receiving screen even if you select "On" from the "Grey Background" in the SETUP menu (→ page 41).</li> </ul>  <p>Play images</p> <p>Current receiving images</p> <ul style="list-style-type: none"> <li>You can change the channel being received by pressing [^ v CH].</li> <li>You cannot change the channel being received while recording.</li> </ul>
<p>Skipping the specified time (Time Slip)  <b>RAM DVD-R</b></p>	<p><b>1 Press [TIME SLIP].</b>  <b>2 Press [▲, ▼] to select the time and press [ENTER].</b>            Play skips the specified time.</p> <ul style="list-style-type: none"> <li>Press [TIME SLIP] to show the play images in full.</li> </ul> <p><b>Note</b>            Time Slip does not work while timer recording is in standby.</p>
<p>Manual Skip  <b>RAM DVD-R</b>            Play restarts from approximately 30 seconds later.</p>	<p><b>Press [MANUAL SKIP].</b></p>

Refer to the control reference on page 20.

## Editing operations during play

<p>Erase  <b>RAM DVD-R</b></p>	<p><b>1 Press [ERASE].</b>  <b>2 Press [◀, ▶] to select “Erase” and press [ENTER].</b>                  ● A title cannot be restored once it is erased. Make certain before proceeding.                  ● You cannot erase when recording and playing at the same time.</p>
<p>Create chapter                  (⇒ page 28, Title/Chapter)  <b>RAM</b></p>	<p><b>Press [CREATE CHAPTER].</b>                  ● Press [◀◀, ▶▶] to skip to the start of a chapter.                  ● You cannot divide when recording and playing at the same time.</p>

## Changing audio

Press [AUDIO].

**RAM VCD**  
 LR → L → R  
 ↑

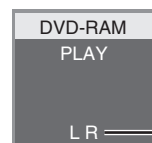

e.g., “L R” is selected

**DVD-V DVD-A**

You can change the audio channel number each time you press the buttons. This allows you to change things like the soundtrack language (⇒ page 26, Soundtrack).



e.g., English is selected.

### Note

You cannot change the audio type in the following cases.

- When a DVD-R disc is in the disc tray while DVD drive is selected.
- When the recording mode is XP and “Audio Mode for XP Recording” is set to “LPCM” (⇒ page 41).

# Using menus to play MP3

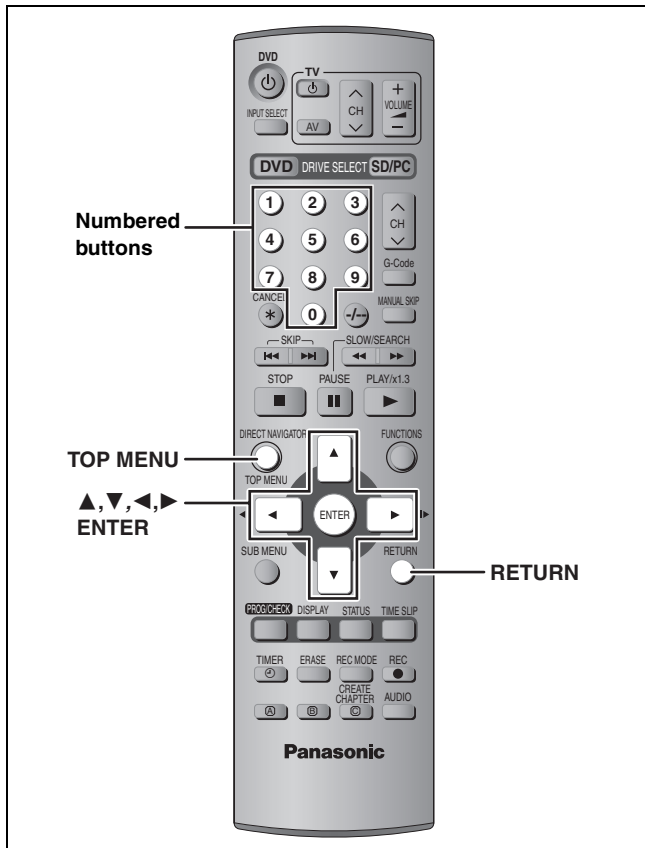

**CD** (MP3 discs only)

This unit plays MP3 files recorded on CD-R/RW designed for audio recording that are finalized (→ page 46) on a computer. Files are treated as tracks and folders are treated as groups.

## 1 Press [TOP MENU].

**G:** Group no.  
**T:** Track no. in the group  
**TOTAL:** Track no./Total track no. in all groups

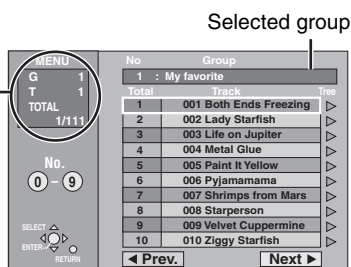

## 2 Press [▲, ▼] to select the track and press [ENTER].

Play continues to the last track in the last group.

- “” indicates the track currently playing.
- You can also select the track with the numbered buttons.  
 e.g., 5: [0] → [0] → [5]  
 15: [0] → [1] → [5]

### To show other pages

Press [▲, ▼, ◀, ▶] to select “Prev.” or “Next” and press [ENTER]. After listing all the tracks in one group, the list for the next group appears.

### To exit the screen

Press [TOP MENU].

## Using the tree screen to find a group

While the file list is displayed

### 1 Press [▶] while a track is highlighted to display the tree screen.

Selected group no. /Total group no.  
 If the group has no track, “- -” is displayed as group number.

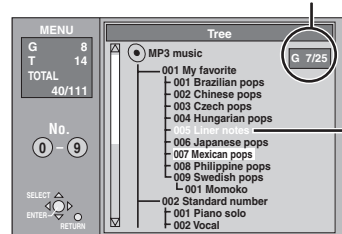

### 2 Press [▲, ▼, ◀, ▶] to select a group and press [ENTER].

The file list for the group appears.

### To return to the file list

Press [RETURN].

### Tips for making MP3 discs

- Discs must conform to ISO9660 level 1 or 2 (except for extended formats).
- Compatible compression rate: between 32 kbps and 320 kbps
- Compatible sampling rate: 16 kHz, 22.05 kHz, 24 kHz, 32 kHz, 44.1 kHz and 48 kHz
- Maximum number of tracks and groups recognizable:  
 999 tracks and 99 groups
- This unit is compatible with multi-session.
- This unit is not compatible with ID3 tags or packet writing.
- Depending on the recording, some items may not be playable.
- Reading or play of the disc may take time if there are a lot of still pictures or sessions.
- The display order may differ from how the order is displayed on a computer.

### Naming folders and files

- MP3 files must have the extension “.MP3” or “.mp3”.
- At the time of recording, give folder and file names a 3-digit numeric prefix in the order you want them to play (this may not work at times).
- English alphabets and Arabic numerals are displayed correctly. Other characters may not be displayed correctly.

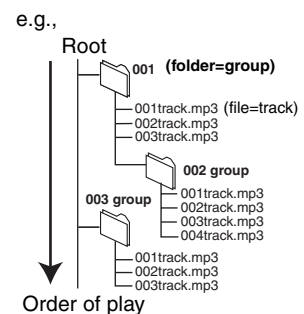

# Playing still pictures

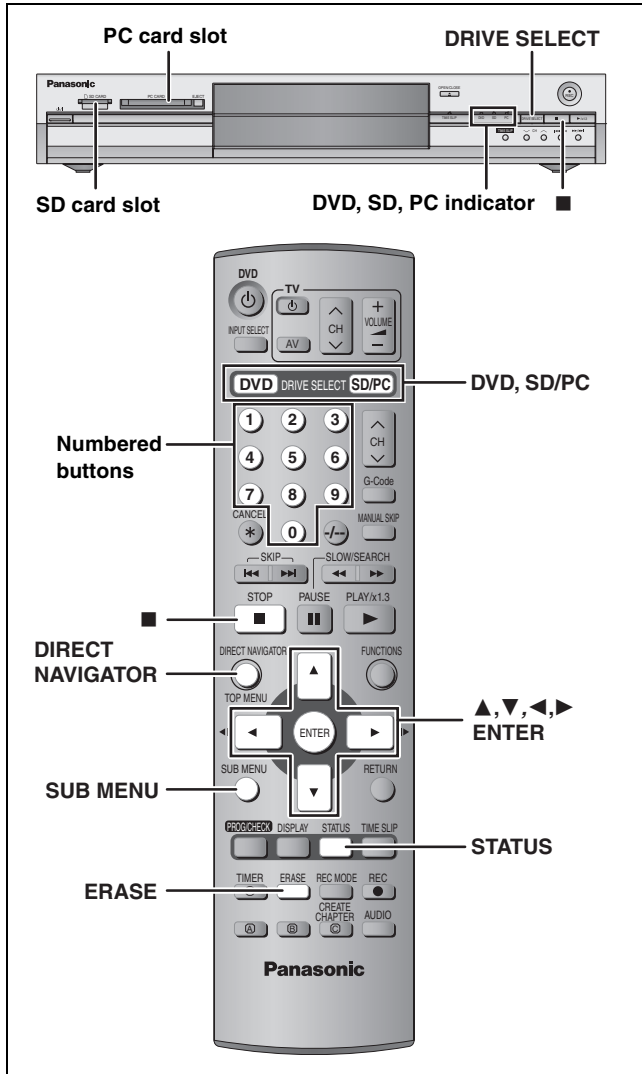

## Regarding still pictures (JPEG, TIFF)

- Compatible formats: DCF\* compliant (Content recorded on a digital camera etc.)
- \* Design rule for Camera File system: unified standard established by Japan Electronics and Information Technology Industries Association (JEITA).
- File format: JPEG, TIFF (non-compressed RGB chunky format)
- Number of pixels: 34×34 to 6144×4096  
(Sub sampling is 4:2:2 or 4:2:0)
- This unit can handle a maximum of 3000 files and 300 folders (including higher folders).
- Operation may take time to complete when playing TIFF format still pictures, or when there are many files and/or folders, some files may not display or be playable.
- MOTION JPEG is not supported.

## Inserting/Removing the SD/PC card

**Only insert or remove the SD/PC card after turning the unit off.** When the card indicator ("SD" or "PC") on the unit's display is flashing, the card is being read from or written to. Do not turn off the unit or remove the card. Such action may result in malfunction or loss of the card's contents.

### ■ SD card slot

#### Inserting the card

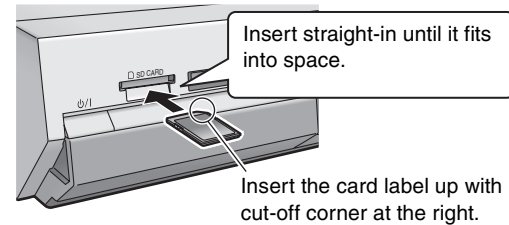

#### Removing the card

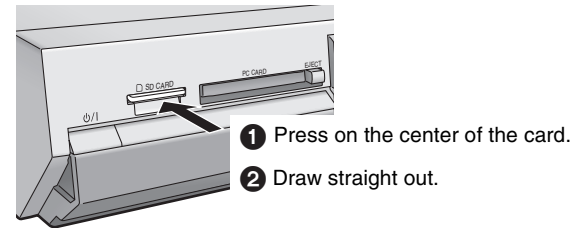

### ■ PC card slot

#### Inserting the card

There are cards requiring adapters (⇒ page 13).

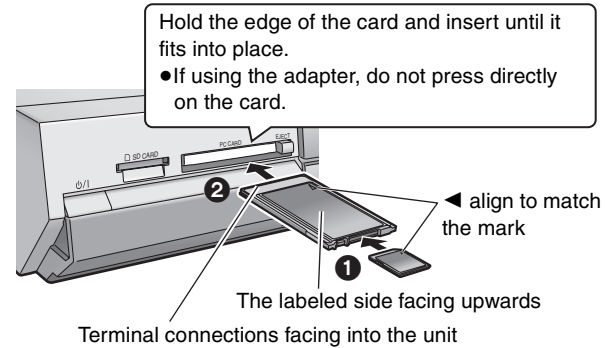

#### Removing the card

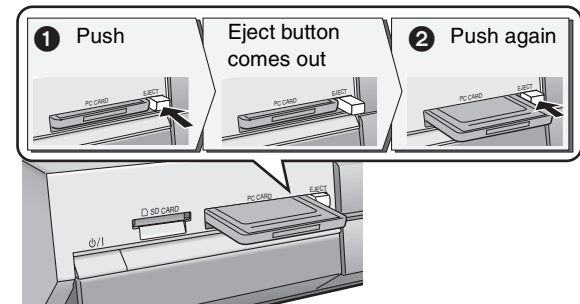

• If using the adapter, remove the adapter and card together.



RAM SD PC

# 1 Press [DVD] or [SD/PC] to select the drive.

- Each time you press [SD/PC]:  
SD card drive ↔ PC card drive
- On the main unit, press [DRIVE SELECT] several times.  
e.g., SD card drive



# 2 Press [DIRECT NAVIGATOR].

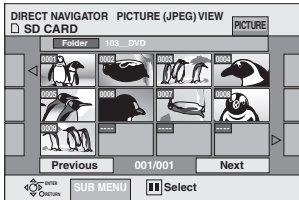

PICTURE (JPEG) VIEW screen

# 3 Press [▲, ▼, ◀, ▶] to select "PICTURE" tab and press [ENTER].

# 4 Press [▲, ▼, ◀, ▶] to select the still picture and press [ENTER].

- You can also select still pictures with the numbered buttons.
- e.g.,
- 5: [0] → [0] → [0] → [5]      115: [0] → [1] → [1] → [5]
- 15: [0] → [0] → [1] → [5]      1115: [1] → [1] → [1] → [5]
- Press [◀, ▶] to display the previous or next still picture.
  - Useful functions during still picture play (⇒ below)

### To stop playing

Press [■].

### To exit the screen

Press [DIRECT NAVIGATOR].

## ■ To select the still pictures in another folder

(⇒ page 13, Structure of folders displayed by this unit)

- 1 Press [▲, ▼, ◀, ▶] to select "Folder" and press [ENTER].
- 2 Press [▲, ▼] to select the folder and press [ENTER].



You can also select folders with the numbered buttons.

- e.g., 5: [0] → [0] → [5]
- 15: [0] → [1] → [5]
- 115: [1] → [1] → [5]

- If there is a multiple number of higher folders recognizable, you can switch them using [◀, ▶].



## ■ To show the picture properties

Press [STATUS] twice.

Shooting date



### To exit the picture properties screen

Press [STATUS].

### Note

- Still pictures cannot be played during recording.
- DVD is always selected as the drive when the unit is turned off and then turned back on.

## Useful functions during still picture play

RAM SD PC

### Start Slide Show Slide Interval

You can display still pictures one by one with constant interval.

While the PICTURE (JPEG) VIEW screen is displayed

- 1 Press [SUB MENU].
- 2 Press [▲, ▼] to select "Start Slide Show" and press [ENTER].

#### •To change the display timing

- 1 Press [▲, ▼] to select "Slide Interval" in step 2 and press [ENTER].
- 2 Press [◀, ▶] to select the desired timing (0–30 seconds) and press [ENTER].

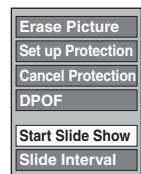

### Rotate

- 1 Press [SUB MENU].
- 2 Press [▲, ▼] to select "Rotate RIGHT" or "Rotate LEFT" and press [ENTER].

- Rotation information will not be stored.

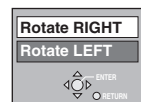

### Zoom in Zoom out

(Only for a still picture with a low pixel count)

- 1 Press [SUB MENU].
- 2 Press [▲, ▼] to select "Zoom in" and press [ENTER].

- To return the picture to its original size, press [▲, ▼] to select "Zoom out" in step 2 and press [ENTER].
- When zooming in, the picture may be cut off.
- The enlargement information will not be stored.

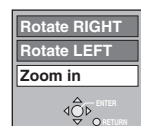

### Erase

- 1 Press [ERASE].
- 2 Press [◀, ▶] to select "Erase" and press [ENTER].

- Once erased, the recorded contents are lost and cannot be restored. Make certain before proceeding.

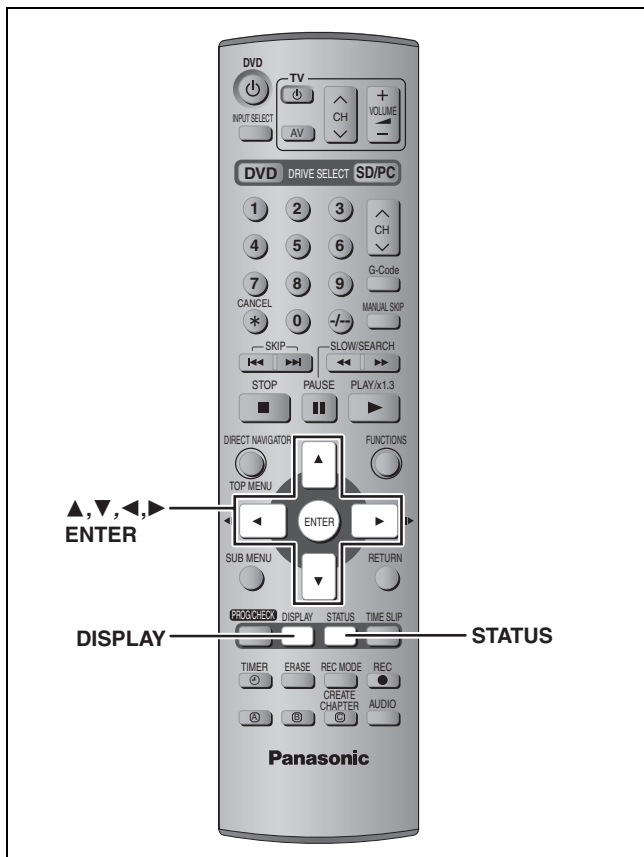

## On-screen menus

### 1 Press [DISPLAY].

Disc	Soundtrack	1	DD Digital 2/0 ch
Play	Subtitle		OFF
Picture	Audio channel		L R
Sound			
<b>Menu</b>	<b>Item</b>	<b>Setting</b>	

- Depending on the condition of the unit (playing, stopped, etc.) and disc contents, there are some items that you cannot select or change.

### 2 Press [▲, ▼] to select the menu and press [▶].

### 3 Press [▲, ▼] to select the item and press [▶].

### 4 Press [▲, ▼] to select the setting.

- Some items can be changed by pressing [ENTER].

#### To clear the on-screen menus

Press [DISPLAY].

## Disc menu—Setting the disc content

### Soundtrack\*

**RAM DVD-R**

The disc's audio attributes appear.

**DVD-A DVD-V**

Select the audio and language (⇒ below, Audio attribute, Language).

### Subtitle\*

**RAM DVD-R** (Only discs that contain subtitle on/off information)

**DVD-A DVD-V**

Turn the subtitle on/off and select the language (⇒ below, Language).

- Subtitle on/off information cannot be recorded using this unit. **RAM DVD-R**

### Audio channel **RAM VCD**

⇒ page 22, Changing audio

### Angle\* **DVD-A DVD-V**

### STILL-P (Still picture) **DVD-A**

Selects the play method for still pictures.

**Slide Show:** Plays according to the default order on the disc.

**Page:** Select the still picture number and play.

- **RANDOM:** Plays in random order.

- **Return:** Returns to the default still picture on the disc.

### PBC (Playback control ⇒ page 46) **VCD**

Indicates whether menu play (playback control) is on or off.

\* You may have to use the menus (⇒ page 20) on the disc to make changes.

- The display changes according to the disc content. You cannot change when there is no recording.

### Audio attribute

LPCM/PPCM/DD Digital/DTS/MPEG:	Signal type
k (kHz):	Sampling frequency
b (bit):	Number of bits
ch (channel):	Number of channels

### Language

ENG: English	SVE: Swedish	CHI: Chinese
FRA: French	NOR: Norwegian	KOR: Korean
DEU: German	DAN: Danish	MAL: Malay
ITA: Italian	POR: Portuguese	VIE: Vietnamese
ESP: Spanish	RUS: Russian	THA: Thai
NLD: Dutch	JPN: Japanese	*: Others

## Play menu—Change the play sequence

This function works only when the elapsed play time is displayed.

### Repeat play

- All VCD CD (excluding MP3 discs)
- Chapter RAM DVD-R DVD-V
- Group DVD-A CD (MP3 discs only)
- PL (Play list) RAM
- Title RAM DVD-R DVD-V
- Track DVD-A VCD CD

Select "OFF" to cancel.

## Picture menu—Change the picture quality

### Playback NR

Reduces noise and picture degradation.

### Progressive\* (⇒ page 46)

Select "ON" to enable progressive output.  
Select "OFF" if the picture is stretched horizontally.

### Transfer\* [When "Progressive" (⇒ above) is set to "ON".]

Select the method of conversion for progressive output to suit the type of material being played (⇒ page 46, Film and video).

When the output signal is PAL

- **Auto** Detects 25 frame-per-second film content and appropriately converts it.
- **Video:** Select when using "Auto", and the video content is distorted.

When the output signal is NTSC

- **Auto1** Detects 24 frame-per-second film content and appropriately converts it.
- **Auto2:** Compatible with 30 frame-per-second film content in addition to 24 frame-per-second film content. (Picture distortion may occur depending on the content)
- **Video:** Select when using "Auto1" and "Auto2", and the video content is distorted.

\* Only when you have set "Progressive" to "On" in the SETUP menu (⇒ page 10).

## Sound menu—Change the sound effect

### V.S.S. RAM DVD-R DVD-V

(Dolby Digital, MPEG, 2-channel or over only)

Enjoy a surround-like effect if you are using two front speakers only.

- Turn V.S.S. off if it caused distortion.
- V.S.S. does not work for bilingual recordings.

### Dialog Enhancer DVD-A DVD-V

(Dolby Digital, 3-channel or over only, including a centre channel)

The volume of the centre channel is raised to make dialogue easier to hear.

## Status messages

Status messages appear on the television when you operate the unit to show the condition of the unit.

### Press [STATUS].

The display changes each time you press the button.

- Displayed information are examples.

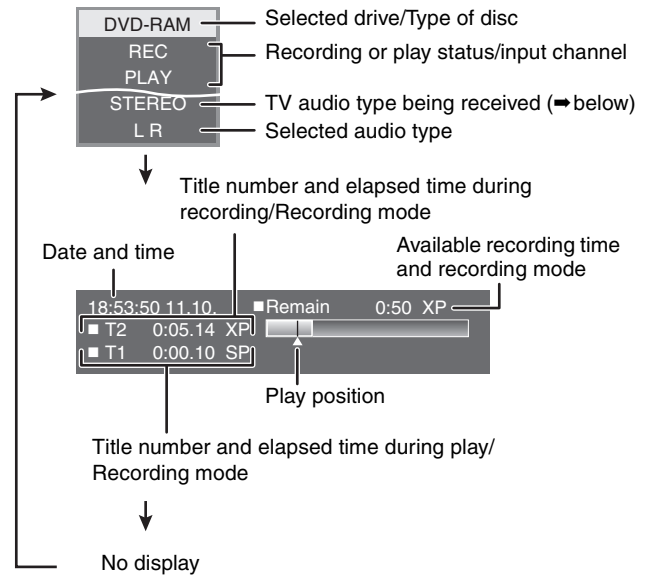

### • TV audio type

**STEREO:** STEREO/NICAM stereo broadcast

**M 1/M 2:** Bilingual/NICAM dual-sound broadcast

**M 1:** NICAM monaural broadcast

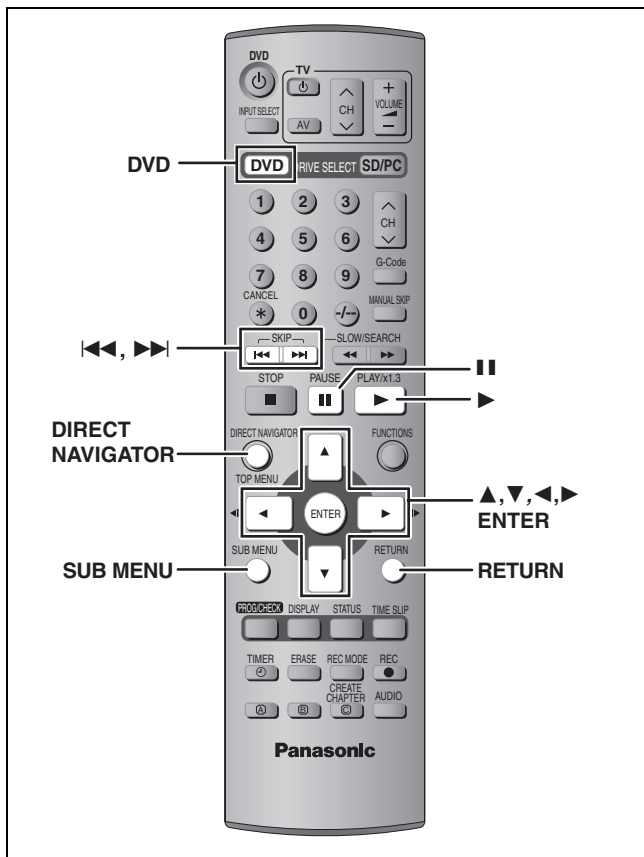

**RAM DVD-R**

**Title/Chapter**  
Programmes are recorded as a single title consisting of one chapter.

Title

Chapter

Start End

↓

You can divide a title into multiple chapters. **RAM**  
(⇒ page 22, 29, Create Chapter)

Title

Chapter
Chapter
Chapter
Chapter

↓

You can change the order of chapters and create a play list  
(⇒ page 30). **RAM**

- Titles are divided into about 5-minute chapters after finalizing (⇒ page 37). **DVD-R**

- The maximum number of items on a disc:
  - Titles: 99
  - Chapters: Approximately 1000  
(Depends on the state of recording.)

**Note**

- Once erased, divided or partially erased, it cannot be restored to its original state. Make certain before proceeding.
- You cannot edit during recording or chasing play.
- Restricted recording information remains even after editing (e.g. dividing a title etc.)

## Editing titles/chapters and playing chapters

**Preparation**

- Press [DVD] to select the DVD drive.
- Release protection (⇒ page 36). **RAM**

- 1 Press [DIRECT NAVIGATOR].
- 2 Press [▲, ▼, ◀, ▶] to select “VIDEO” tab and press [ENTER].
- 3 Press [▲, ▼, ◀, ▶] to select the title.

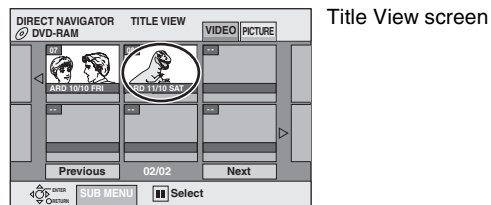

**To show other pages**

Press [▲, ▼, ◀, ▶] to select “Previous” or “Next” and press [ENTER].

- You can also press [◀◀, ▶▶] to show other pages.

**Multiple editing**

Select with [▲, ▼, ◀, ▶] and press [■]. (Repeat.) A check mark appears. Press [■] again to cancel.

- 4 Press [SUB MENU], then [▲, ▼] to select the operation and press [ENTER].

- If you select “Edit”, press [▲, ▼] to select the operation and press [ENTER].

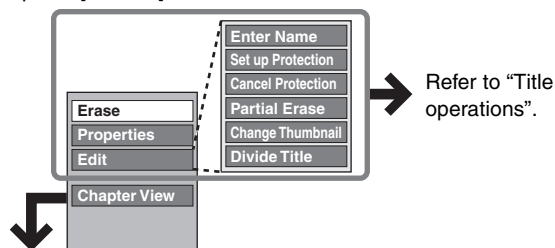

- If you select “Chapter View”

- 5 Press [▲, ▼, ◀, ▶] to select the chapter.

To start play ⇒ Press [ENTER].

To edit ⇒ Step 6.

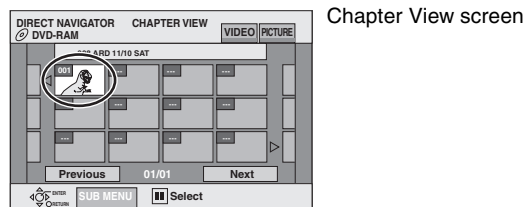

- To show other pages/Multiple editing (⇒ above)

- 6 Press [SUB MENU], then [▲, ▼] to select the operation and press [ENTER].

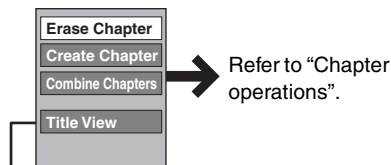

- You can go back to Title View.



**To exit the screen**

Press [DIRECT NAVIGATOR].

**To return to the previous screen**

Press [RETURN].

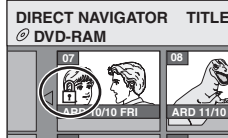
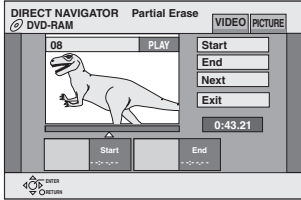
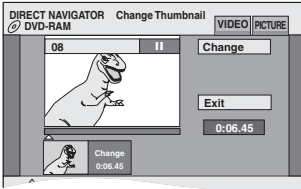
## Title operations

<b>Erase*</b> <b>RAM DVD-R</b>	<p><b>Press [◀, ▶] to select “Erase” and press [ENTER].</b></p> <ul style="list-style-type: none"> <li>•Once erased, the recorded contents are lost and cannot be restored. Make certain before proceeding.</li> <li>•The available recording time on DVD-R does not increase when you erase titles.</li> </ul>
<b>Properties</b> <b>RAM DVD-R</b>	<p>Information (e.g., time and date) is shown.</p> 
<b>Enter Name</b> <b>RAM DVD-R</b>	<p>You can give names to recorded titles.            →page 38, Entering text</p>
<b>Set up Protection*</b> <b>Cancel Protection*</b> <b>RAM</b>	<p>If set, this will protect the title from accidental erasure.</p> <p><b>Press [◀, ▶] to select “Yes” and press [ENTER].</b></p> <p>The lock symbol appears when the title is protected.</p> 
<b>Partial Erase</b> <b>RAM</b>	<p>You can remove unnecessary parts of the recording such as commercials.</p> <ol style="list-style-type: none"> <li><b>1 Press [ENTER] at the start point and end point of the section you want to erase.</b></li> <li><b>2 Press [▲, ▼] to select “Exit” and press [ENTER].</b>            •Select “Next” and press [ENTER] to erase other sections.</li> <li><b>3 Press [◀, ▶] to select “Erase” and press [ENTER].</b></li> </ol> 
<b>Change Thumbnail</b> <b>RAM DVD-R</b>	<p>You can change an image to be shown as a thumbnail picture in the Title View.</p> <ol style="list-style-type: none"> <li><b>1 Press [▶] (PLAY) to start play.</b></li> <li><b>2 Press [ENTER] when the image you want to use as a thumbnail is shown.</b></li> <li><b>3 Press [▲, ▼] to select “Exit” and press [ENTER].</b></li> </ol> 
<b>Divide Title</b> <b>RAM</b>	<p>You can divide a title into two.</p> <ol style="list-style-type: none"> <li><b>① Press [ENTER] at the point you want to divide the title.</b></li> <li><b>② Press [▲, ▼] to select “Exit” and press [ENTER].</b></li> <li><b>③ Press [◀, ▶] to select “Divide” and press [ENTER].</b></li> </ol> <p><b>To confirm the division point</b>            Press [▲, ▼] to select “Preview” and press [ENTER]. (The unit plays 10 seconds before and after the division point.)</p> <p><b>To change the division point</b>            Restart play and press [▲, ▼] to select “Divide”, then press [ENTER] at the point you want to change.</p> <p><b>Note</b></p> <ul style="list-style-type: none"> <li>•The divided titles retain the title name and CPRM property (→page 46) of the original title.</li> <li>•Video and audio just before and after the dividing point may momentarily cut out.</li> </ul> 

\* Multiple editing is possible.

## Chapter operations

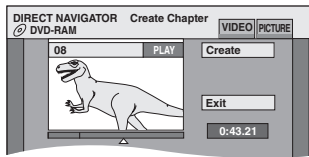
<b>Erase Chapter*</b> <b>RAM</b>	<p><b>Press [◀, ▶] to select “Erase” and press [ENTER].</b></p> <ul style="list-style-type: none"> <li>•Once erased, the recorded contents are lost and cannot be restored. Make certain before proceeding.</li> </ul>
<b>Create Chapter</b> <b>RAM</b>	<ol style="list-style-type: none"> <li><b>1 Press [ENTER] at the point you want to divide.</b>            •Repeat this step to divide at other points.</li> <li><b>2 Press [▲, ▼] to select “Exit” and press [ENTER].</b></li> </ol> 
<b>Combine Chapters</b> <b>RAM</b>	<p><b>Press [◀, ▶] to select “Combine” and press [ENTER].</b></p> <ul style="list-style-type: none"> <li>•The selected chapter and next chapter are combined.</li> </ul>

\* Multiple editing is possible.

### For quicker editing

- Use search, Time Slip or slow-motion (→page 21) to find the desired point.
- Press [◀◀, ▶▶] to skip to the end of a title.

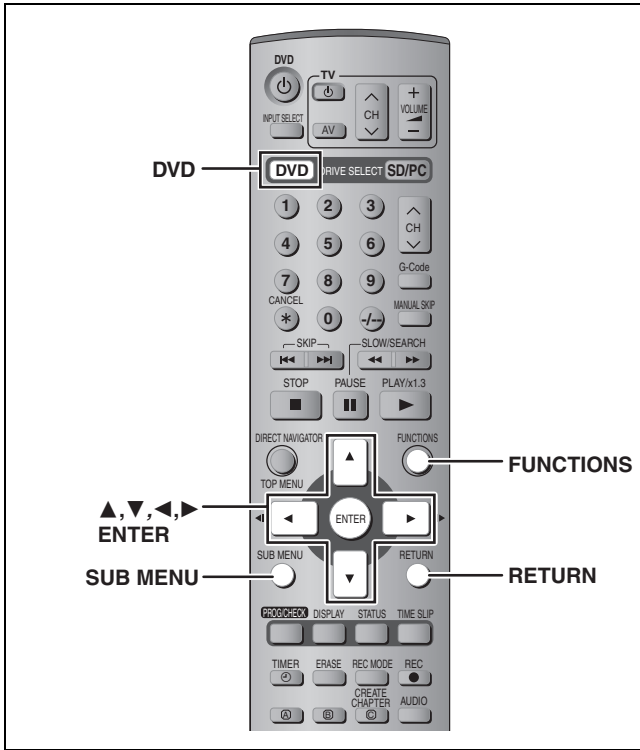

## RAM

You can arrange the chapters (→ page 28) to create a play list.

Title			Title	
Chapter	Chapter	Chapter	Chapter	Chapter

↓ ↓

Play list    Chapter    Chapter

- Editing play lists doesn't modify the recording data.
- Play lists are not recorded separately so this doesn't use much capacity.

- The maximum number of items on a disc:
  - Play lists: 99
  - Chapters in play lists: Approximately 1000 (Depends on the state of recording.)

## Note

You cannot create or edit a play list while recording.

## Creating play lists

### Preparation

- Press [DVD] to select the DVD drive.
- Release protection (→ page 36).

- 1 While stopped  
Press [FUNCTIONS].

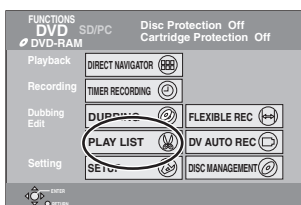

- 2 Press [▲, ▼, ◀, ▶] to select “PLAY LIST” and press [ENTER].

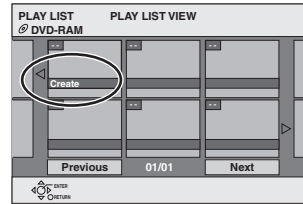

- 3 Press [▲, ▼, ◀, ▶] to select “Create” and press [ENTER].
- 4 Press [◀, ▶] to select the source title and press [▼].

- Press [ENTER] to select all the chapters in the title, then skip to step 6.

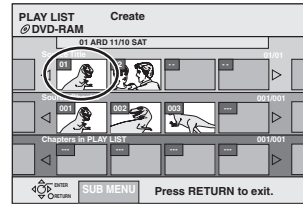

- 5 Press [◀, ▶] to select the chapter you want to add to a play list and press [ENTER].

Press [▲] to cancel.

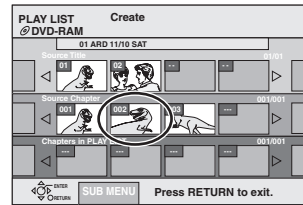

- You can also create a new chapter from the source title. Press [SUB MENU] to select “Create Chapter” and press [ENTER] (→ page 29, Create Chapter)

- 6 Press [◀, ▶] to select the position to insert the chapter and press [ENTER].

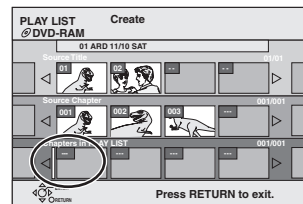

- Press [▲] to select other source titles.
- Repeat steps 5–6 to add other chapters.

- 7 Press [RETURN].

### To exit the screen

Press [RETURN] several times.

### To return to the previous screen

Press [RETURN].

## Editing and playing play lists/chapters

- 1 Press [FUNCTIONS].
- 2 Press [▲, ▼, ◀, ▶] to select “PLAY LIST” and press [ENTER].
- 3 Press [▲, ▼, ◀, ▶] to select the play list.

To start play → Press [ENTER].

To edit → Step 4.

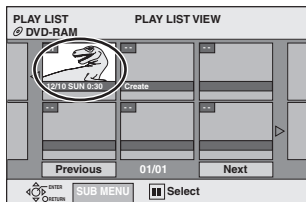

PLAY LIST View screen

•To show other pages/Multiple editing (→ page 28)

- 4 Press [SUB MENU], then [▲, ▼] to select the operation and press [ENTER].

•If you select “Edit”, press [▲, ▼] to select the operation and press [ENTER].

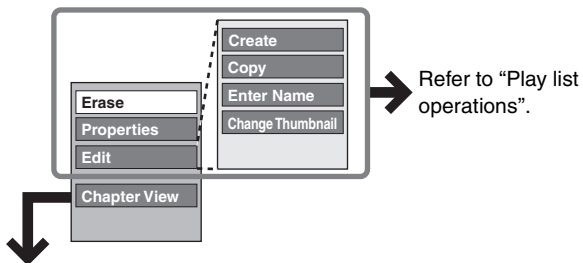

■ If you select “Chapter View”

- 5 Press [▲, ▼, ◀, ▶] to select the chapter.

To start play → Press [ENTER].

To edit → Step 6.

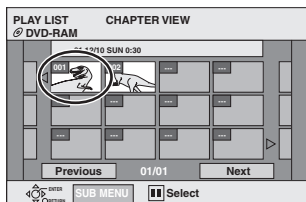

Chapter View screen

•To show other pages/Multiple editing (→ page 28)

- 6 Press [SUB MENU], then [▲, ▼] to select the operation and press [ENTER].

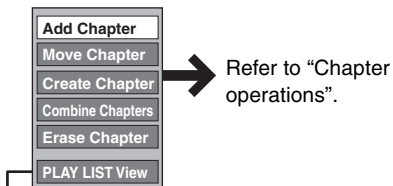

•You can go back to PLAY LIST View.

### To exit the screen

Press [RETURN] several times.

### To return to the previous screen

Press [RETURN].

## Play list operations

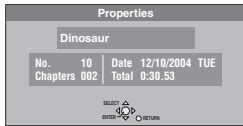
Erase*	Press [◀, ▶] to select “Erase” and press [ENTER].
Properties	Play list information (e.g., time and date) is shown. 
Create	→ page 30, Creating play lists
Copy*	Press [◀, ▶] to select “Copy” and press [ENTER].
Enter Name	You can give names to play lists. → page 38, Entering text
Change Thumbnail	→ page 29, Change Thumbnail

\* Multiple editing is possible.

## Chapter operations

Editing chapters in a play list does not modify the source titles and source chapters.

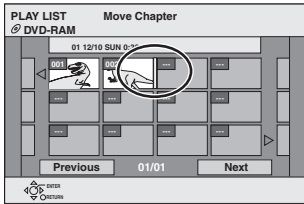
Add Chapter	→ page 30, Creating play lists, Step 4–6
Move Chapter	Press [▲, ▼, ◀, ▶] to select the position to insert the chapter and press [ENTER]. 
Create Chapter	→ page 29, Create Chapter
Combine Chapters	→ page 29, Combine Chapters
Erase Chapter*	→ page 29, Erase Chapter

\* Multiple editing is possible.

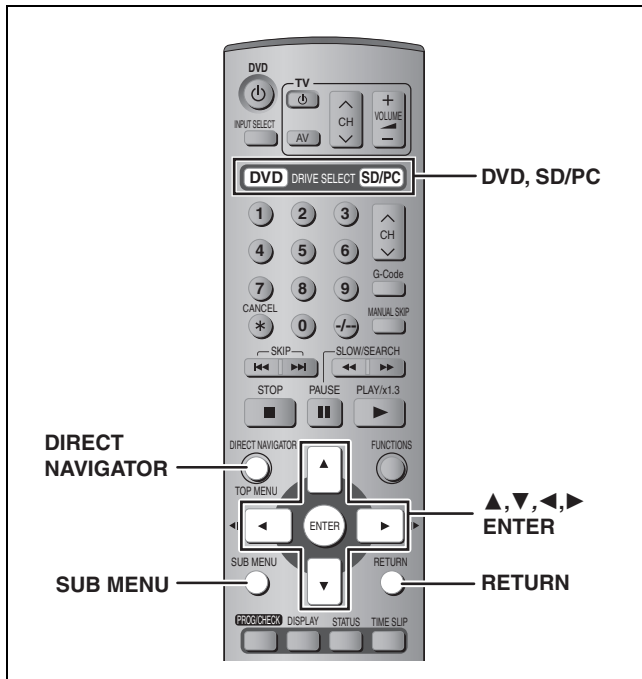

**RAM SD PC**

### Preparation

- Press [DVD] or [SD/PC] to select the drive.
- Release protection (⇒ page 36).

## 1 Press [DIRECT NAVIGATOR].

- 2** **RAM**  
Press [**▲**, **▼**, **◀**, **▶**] to select “**PICTURE**” tab and press [ENTER].
- 3** Press [**▲**, **▼**, **◀**, **▶**] to select the still picture.  
  - To show other pages/Multiple editing (⇒ page 28)
  - To select the still pictures in another folder (⇒ page 25)
- 4** Press [SUB MENU], then [**▲**, **▼**] to select the operation and press [ENTER].

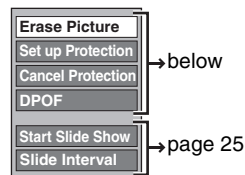

### ■ To edit still picture folders

In step 3 (⇒ above)

- 1 Press [**▲**, **▼**, **◀**, **▶**] to select “**Folder**” and press [ENTER].
- 2 Press [**▲**, **▼**] to select the folder.  
  - To show other pages/Multiple editing (⇒ page 28)
- 3 Press [SUB MENU], then [**▲**, **▼**] to select the operation and press [ENTER].

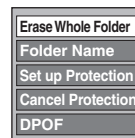

- To select another higher folder (⇒ page 25)

**To exit the screen**  
Press [DIRECT NAVIGATOR].

**To return to the previous screen**  
Press [RETURN].

## Picture and folder operation

<p>Erase Picture* Erase Whole Folder* <b>RAM SD PC</b></p>	<p><b>Press [<b>◀</b>, <b>▶</b>] to select “Erase” and press [ENTER].</b></p> <ul style="list-style-type: none"> <li>• Once erased, the recorded contents are lost and cannot be restored. Make certain before proceeding.</li> <li>• When erasing a folder, even the files not containing still pictures will also be erased if they are inside the folder. (This does not apply to folders under the folder concerned.)</li> </ul>
<p>Set up Protection* Cancel Protection* <b>RAM SD PC</b></p>	<p>If set, this will protect the still picture or folder from accidental erasure.</p> <p><b>Press [<b>◀</b>, <b>▶</b>] to select “Yes” and press [ENTER].</b></p> <p>The lock symbol appears when the still picture or folder is protected.</p> <ul style="list-style-type: none"> <li>• Even if the protection setting is used by this unit to protect a folder, the folder may be erased by another unit.</li> </ul>
<p>DPOF* <b>SD PC</b></p>	<p>You can select a whole folder or individual pictures for printing and specify the number of prints to be made.</p> <p><b>Press [<b>◀</b>, <b>▶</b>] to select number of print (0 to 9) and press [ENTER].</b></p> <p>The DPOF mark appears.</p> <ul style="list-style-type: none"> <li>• This appears on the still pictures inside a folder when you make the DPOF setting for the folder.</li> </ul> <p><b>To cancel the print setting</b> Set the number of print to “0”.</p> <ul style="list-style-type: none"> <li>• When this is set by this unit, any settings established by other units will be released.</li> <li>• Print settings (DPOF) made using this unit may not be viewable on other equipment.</li> <li>• Settings cannot be made for folders and files not in accordance with DCF standards or if there is no remaining space on the card.</li> </ul>
<p>Folder Name <b>RAM SD PC</b></p>	<p>You can give names to still picture folders.</p> <p>⇒ page 38, Entering text</p> <ul style="list-style-type: none"> <li>• Folder names inputted using this unit may not be displayed on other equipment.</li> </ul>

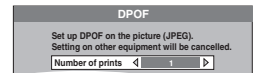
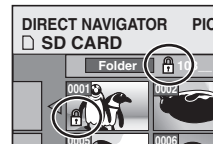

\* Multiple editing is possible.



# Recording from a video cassette recorder

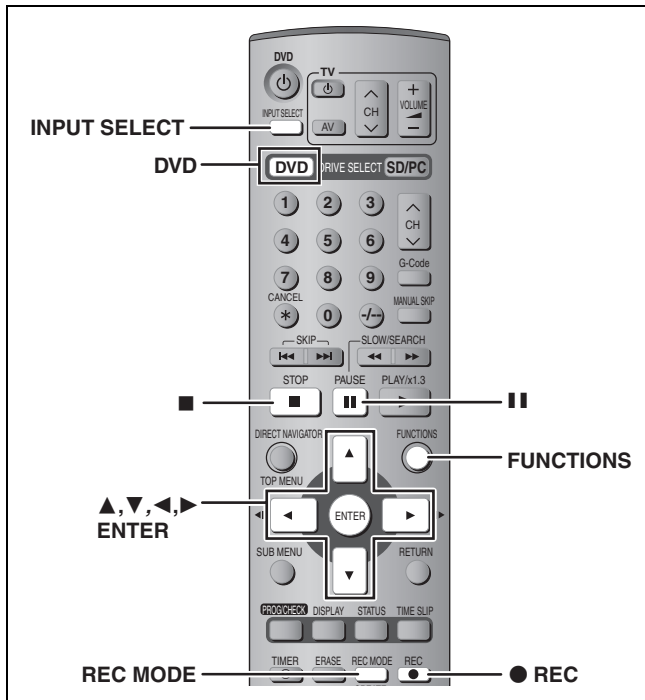

e.g., Connecting other video equipment to the AV3 or DV input terminals

- Turn off the unit and other video equipment before connecting.

This unit

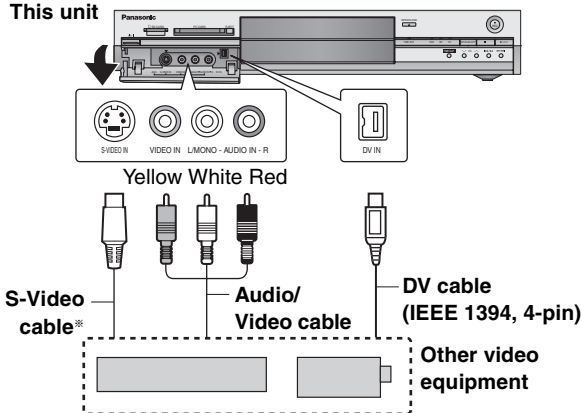

If the audio output of the other equipment is monaural, connect to L/MONO.

\* The S-VIDEO terminal achieves a more vivid picture than the VIDEO terminal.

**When recording from the unit's DV terminal**

Select the type of audio recording from "Audio Mode for DV Input" in the SETUP menu (➔ page 41).

## Manual recording

**RAM DVD-R**

**Preparation**

- Connect a video cassette recorder to this unit's input terminals.
- Press [DVD] to select the DVD drive.
- When recording bilingual programmes

**RAM**

When both M 1 and M 2 is selected on the connected equipment, you can select the audio type in playback.

**DVD-R**

Select either M 1 or M 2 on the connected equipment. (You cannot select the audio type in playback.)

- When the output signal from the external equipment is NTSC, change the "TV System" to "NTSC" in the SETUP menu (➔ page 43).
- To reduce noise in input from a video cassette recorder, set "AV-in NR" to "On" in the SETUP menu (➔ page 40).

**1 While stopped**

**Press [INPUT SELECT] to select the input channel for the equipment you have connected.**

e.g., If you have connected to AV3 input terminals, select "AV3".

**2 Press [REC MODE] to select the recording mode.**

**3 Start play on the other equipment.**

**4 Press [● REC].**

Recording starts.

**To skip unwanted parts**

Press [■] to pause recording. (Press again to restart recording.)

**To stop recording**

Press [■].

**To record programmes to fill up the remaining space on the disc**

➔ page 16, Flexible Recording

**Almost all videos and DVD software on sale have been treated to prevent illegal copying. Any software that has been so treated cannot be recorded using this unit.**

## DV automatic recording (DV AUTO REC)

**RAM**

When the "DV AUTO REC" function is used, programmes are recorded as a title while at the same time chapters are created at each break in the images and the play list is created automatically.

**Preparation**

- 1 Turn off the main unit and DV equipment, then connect the equipment with the unit's DV input terminal (➔ left).
  - 2 Turn on the main unit and DV equipment.
  - 3 Pause play of the DV equipment at the point you want recording to start.
  - 4 Press [DVD] to select the DVD drive.
- When the output signal from the external equipment is NTSC, change the "TV System" to "NTSC" in the SETUP menu (➔ page 43).

**1 While stopped**

**Press [FUNCTIONS].**

**2 Press [▲, ▼, ◀, ▶] to select "DV AUTO REC" and press [ENTER].**

**3 Press [REC MODE] to select the recording mode.**

**4 Press [◀, ▶] to select "Rec" and press [ENTER].**

Recording starts.

**When recording finishes**

The confirmation screen appears. Press [ENTER] to finish DV automatic recording.

**To stop recording**

Press [■].

**Note**

- Only one piece of DV equipment (e.g., digital video camcorder) can be connected to the unit via the DV input terminal.
- It is not possible to operate the unit from the connected DV equipment.
- The DV input on this unit is for use with DV equipment only. (It cannot be connected to a computer, etc.)
- The DV equipment name may not be shown correctly.
- Depending on the DV equipment, the images or audio may not be input properly.
- The date and time information on the tape of the DV equipment will not be recorded.
- You cannot record and play simultaneously.

If the DV automatic recording function does not work properly, check the connections and DV equipment settings, and turn the unit off and back on.

**If that does not work, follow the instructions for manual recording (➔ left).**

# Transferring (dubbing) still pictures

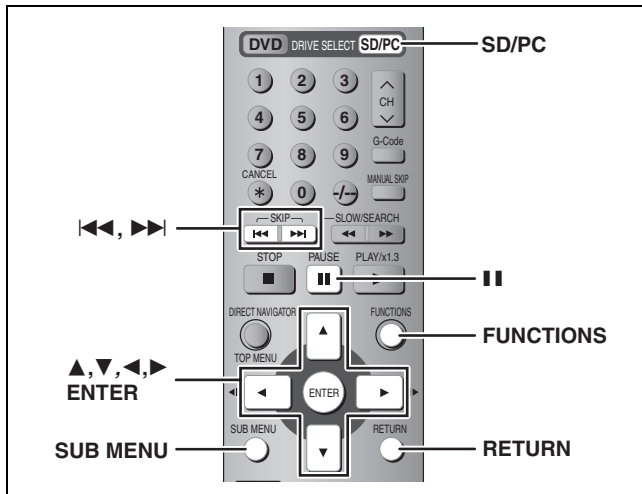

## Transferring (dubbing) using the transferring (dubbing) list

- 1 While stopped  
Press [FUNCTIONS].
- 2 Press [▲, ▼, ◀, ▶] to select “DUBBING” and press [ENTER].

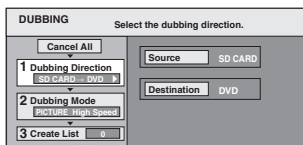

• If you are not going to change the registered list press [▼] several times (⇒ step 6).

- 3 Press [▲, ▼] to select “Dubbing Direction” and press [▶].
  - 1 Press [▲, ▼] to select “Source” and press [ENTER].
  - 2 Press [▲, ▼] to select the drive and press [ENTER].
  - 3 Press [▲, ▼] to select “Destination” and press [ENTER].
  - 4 Press [▲, ▼] to select the drive and press [ENTER].  
The same drive as the transfer (dubbing) source can be selected.
  - 5 Press [◀] to confirm.
- 4 Press [▲, ▼] to select “Create List” and press [▶].  
Select the transferring (dubbing) items and register on the list.

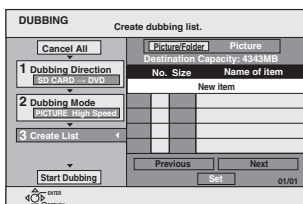

### ■ To register individual still pictures

- 1 Press [▲, ▼] to select “New item” and press [ENTER].
  - 2 Press [▲, ▼, ◀, ▶] to select the still picture and press [ENTER].
- To select a multiple number of items together, press [■] to add the check mark and press [ENTER] (⇒ right, Multiple editing).
  - To show other pages (⇒ right)
  - To select the still pictures in another folder (⇒ right)
  - To edit the transferring (dubbing) list (⇒ right)

### ■ To register on a folder by folder basis

- 1 Press [▲, ▼] to select “Picture/Folder” and press [ENTER].

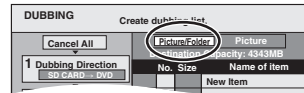

- 2 Press [▲, ▼] to select “Folder” and press [ENTER].
  - 3 Press [▲, ▼] to select “New item” and press [ENTER].
  - 4 Press [▲, ▼] to select the folder and press [ENTER].
- To select a multiple number of items together, press [■] to add the check mark and press [ENTER] (⇒ below, Multiple editing).
  - To show other pages (⇒ below)
  - To switch another higher folder (⇒ below)
  - To edit the transferring (dubbing) list (⇒ below)
- Still pictures and folders cannot be registered on the same list.

- 5 Press [▲, ▼] to select “Set” and press [ENTER].  
The transferring (dubbing) list is registered.

- 6 Press [▲, ▼] to select “Start Dubbing” and press [ENTER].

• For individual still pictures only  
When specifying another folder as the transferring (dubbing) destination, select “Folder”.

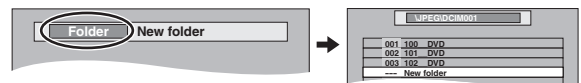

Press [◀, ▶] to select “Yes” and press [ENTER] to start transferring (dubbing).

- To stop transferring (dubbing)  
Press and hold [RETURN] for 3 seconds.

- To return to the previous screen  
Press [RETURN].

### ■ To select another folder

- 1 Press [▲, ▼, ◀, ▶] to select “Folder” and press [ENTER].
- 2 Press [▲, ▼] to select the folder and press [ENTER].



- The still pictures of different folders cannot be registered on the same list.
- If there is a multiple number of higher folders recognizable, you can switch them using [◀, ▶]. (Folders whose higher folders are different cannot be registered on the same list.)

### ■ To edit the transferring (dubbing) list

Select the item in step 4 (⇒ left)

- 1 Press [SUB MENU].
- 2 Press [▲, ▼] to select the operation and press [ENTER].

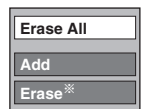

\* Multiple editing is possible (⇒ below).

- To cancel all registered transferring (dubbing) setting and lists  
In step 3 (⇒ left)

- 1 Press [▲, ▼] to select “Cancel All” and press [ENTER].
  - 2 Press [◀, ▶] to select “Yes” and press [ENTER].
- The settings and lists may be cancelled in the following situations.
    - When a still picture or folder has been recorded or erased at the transfer (dubbing) source
    - When steps have been taken, for instance, to turn off the unit, remove the card, open the tray, change the transfer (dubbing) direction, etc.

### To show other pages

Press [▲, ▼, ◀, ▶] to select “Previous” or “Next” and press [ENTER].  
• You can also press [◀◀, ▶▶] to show other pages.

### Multiple editing

Select with [▲, ▼, ◀, ▶] and press [■]. (Repeat.)  
Press [ENTER] to register to the list.

- A check mark appears. Press [■] again to cancel.

**Transferring (dubbing) all the still pictures of a card onto a DVD-RAM  
—COPY ALL PICTURES**

**SD** or **PC** → **RAM**

**Preparation**

Press [SD/PC] to select the source drive.

- 1** While stopped  
Press [FUNCTIONS].
- 2** Press [**▲**, **▼**, **◀**, **▶**] to select “COPY ALL PICTURES” and press [ENTER].

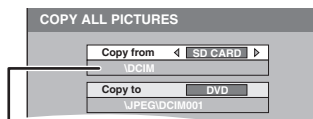

•If there is a multiple number of higher folders recognizable, you can switch them using [**◀**, **▶**].

- 3** Press [**▲**, **▼**] to select “Copy from” and press [**◀**, **▶**] to select the drive.
- 4** Press [**▲**, **▼**, **◀**, **▶**] to select “Copy” and press [ENTER].

**To stop transferring (dubbing)**

Press and hold [RETURN] for 3 seconds.

**To return to the previous screen**

Press [RETURN].

**Note**

- When transferring (dubbing) the still pictures on a folder by folder or card by card basis, files other than the still picture files inside the folder will also be transferred (dubbed). (This does not apply to the lower folders contained inside the folders.)
- If still pictures are already contained inside the transfer (dubbing) destination folder, the new still pictures are recorded following the existing still pictures.
- If the space on the destination drive runs out or the number of files/folders to be transferred (dubbed) exceeds the maximum (→ page 24), transferring (dubbing) will stop partway through.
- When a name has been input by this unit for the transfer (dubbing) source folder, the folder name will be reflected in the transfer (dubbing) destination folder.
- Print number setting (DPOF) is not transferred (dubbed).
- The sequence in which the still pictures are registered on the transfer (dubbing) list may not be reflected at the transfer (dubbing) destination.

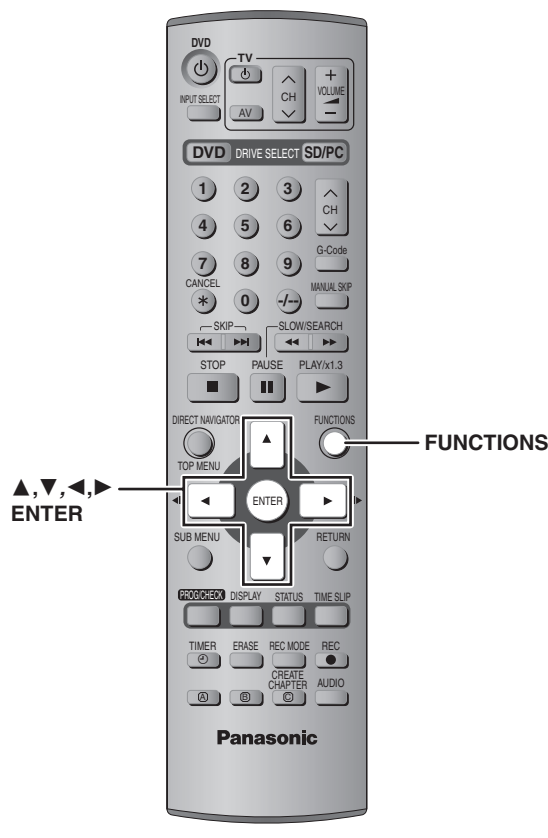

By using the FUNCTIONS window you may access the main functions quickly and easily.

- 1** While stopped  
Press [FUNCTIONS].

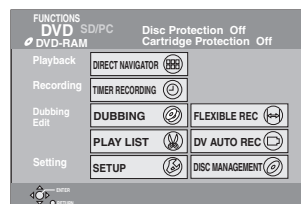

Functions displayed depend on the selected drive or type of disc.

- 2** Press [**▲**, **▼**, **◀**, **▶**] to select an item and press [ENTER].

**To exit the FUNCTIONS window**

Press [FUNCTIONS].

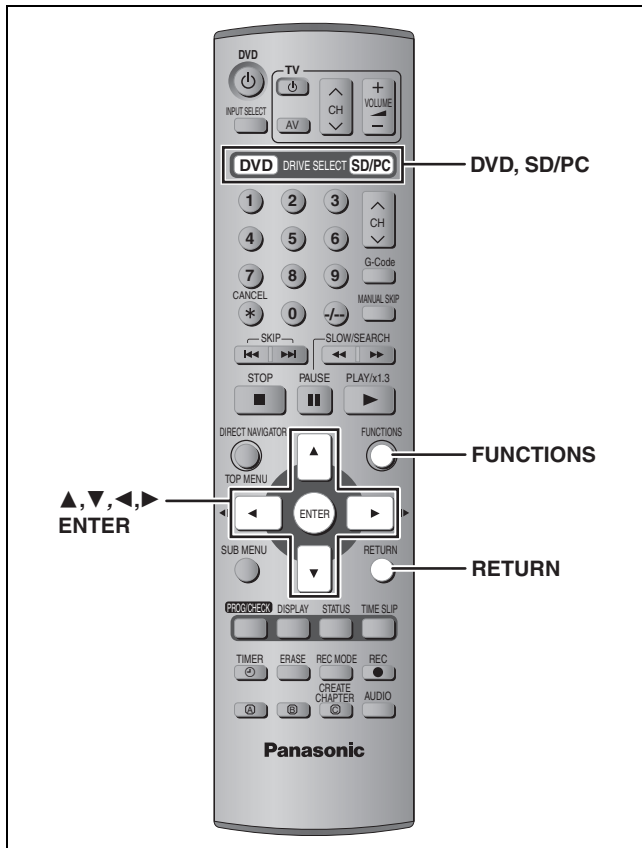

## Setting the protection

### ■ Setting the protection for the whole disc or card

- For a DVD-RAM with a cartridge or for a card

#### RAM

With the write-protect tab in the protect position, play automatically starts when inserted in the unit.



#### SD PC

Switch the write-protect switch to the “LOCK” position.

e.g. SD Memory Card



- For a DVD-RAM without a cartridge (⇒ below, Disc Protection)

### ■ Other protection settings

#### Title

Select “Set up Protection” in step 4 on page 28.

#### Still picture or folder

Select “Set up Protection” in step 4 on page 32.

## Disc Protection

#### RAM

#### Preparation

Press [DVD] to select the DVD drive.

- 1 While stopped  
Press [FUNCTIONS].
- 2 Press [▲, ▼, ◀, ▶] to select “DISC MANAGEMENT” and press [ENTER].
- 3 Press [▲, ▼] to select “Disc Protection” and press [ENTER].

- 4 Press [◀, ▶] to select “Yes” and press [ENTER].

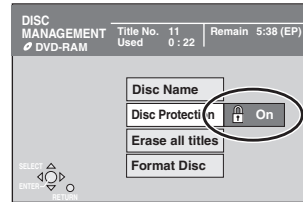

The lock symbol appears closed when the disc is write-protected.

## Providing a disc with a name

#### RAM DVD-R

#### Preparation

- Press [DVD] to select the DVD drive.
- Release protection (⇒ left).

- 1 While stopped  
Press [FUNCTIONS].
- 2 Press [▲, ▼, ◀, ▶] to select “DISC MANAGEMENT” and press [ENTER].
- 3 Press [▲, ▼] to select “Disc Name” and press [ENTER].

⇒ page 38, Entering text

- The disc name is displayed in the FUNCTIONS window.
- With a finalized DVD-R, the name is displayed on the Top Menu.



## Erasing all titles and play lists—Erase all titles

#### RAM

#### Preparation

- Press [DVD] to select the DVD drive.
- Release protection (⇒ left).

- 1 While stopped  
Press [FUNCTIONS].
- 2 Press [▲, ▼, ◀, ▶] to select “DISC MANAGEMENT” and press [ENTER].
- 3 Press [▲, ▼] to select “Erase all titles” and press [ENTER].
- 4 Press [◀, ▶] to select “Yes” and press [ENTER].
- 5 Press [◀, ▶] to select “Start” and press [ENTER].  
A message appears when finished.
- 6 Press [ENTER].

#### Note

- Once erased, the recorded contents are lost and cannot be restored. Make certain before proceeding.
- Still picture data (JPEG, TIFF) or computer data cannot be erased.
- Erase does not work if one or more titles are protected.

## Erasing all the contents of a disc or card—Format

RAM SD PC

### Preparation

- Press [DVD] or [SD/PC] to select the drive.
- Release protection (→ page 36).

- 1** While stopped  
Press [FUNCTIONS].
- 2** Press [▲, ▼, ◀, ▶] to select “DISC MANAGEMENT” or “CARD MANAGEMENT” and press [ENTER].
- 3** Press [▲, ▼] to select “Format Disc” or “Format” and press [ENTER].
- 4** Press [◀, ▶] to select “Yes” and press [ENTER].
- 5** Press [◀, ▶] to select “Start” and press [ENTER].  
A message appears when formatting is finished.
- 6** Press [ENTER].

### Note

• **Formatting erases all contents (including computer data), and it cannot be restored. Check carefully before proceeding.** The contents are erased when you format it even if you have set protection.

• **Do not disconnect the AC mains lead while formatting.** This can render the disc unusable.  
Formatting normally takes a few minutes, however it may take up to a maximum of 70 minutes (RAM).

### • To stop formatting

Press [RETURN].

(You can cancel formatting if it takes more than 2 minutes. The disc or card must be reformatted if you do this.)

- Formatting cannot be performed on DVD-R or CD-R/RW.
- When a disc or card has been formatted using this unit, it may not be possible to use it on any other equipment.
- You cannot format a Microdrive or mobile hard disk on this unit.

## Enabling DVD-R to be played on other equipment—Finalize

DVD-R

### Preparation

Press [DVD] to select the DVD drive.

- 1** While stopped  
Press [FUNCTIONS].
- 2** Press [▲, ▼, ◀, ▶] to select “DISC MANAGEMENT” and press [ENTER].
- 3** Press [▲, ▼] to select “Auto-Play Select” and press [ENTER].  
Press [▲, ▼] to select “Top Menu” or “Title 1” and press [ENTER].  
You can select whether to show the top menu after finalizing.  
Top Menu: The top menu appears first.  
Title 1: The disc content is played without displaying the top menu.
- 4** Press [▲, ▼] to select “Finalize” and press [ENTER].
  - ① Press [◀, ▶] to select “Yes” and press [ENTER].
  - ② Press [◀, ▶] to select “Start” and press [ENTER].  
A message appears when finalizing is finished.
  - ③ Press [ENTER].

### Note

#### After finalizing

• **The disc becomes play-only and you can no longer record or edit.**

• Titles are divided into about 5-minute\* chapters.

\* This time varies greatly depending on the condition and mode of recording.

• There is a pause of several seconds between titles during play.

**Do not disconnect the AC mains lead while finalizing.** This will render the disc unusable.

Finalizing takes up to 15 minutes.

- You cannot finalize DVD-R recorded on other manufacturer's equipment.

	Before finalizing	After finalizing
Disc display on this unit	DVD-R	DVD-V
Recording/Editing/Entering name	✓	×
Play on other players	×	✓

DVD-R finalized on this unit may not be playable on other players due to the condition of the recording.

### To exit the screen

Press [RETURN] several times.

### To return to the previous screen

Press [RETURN].

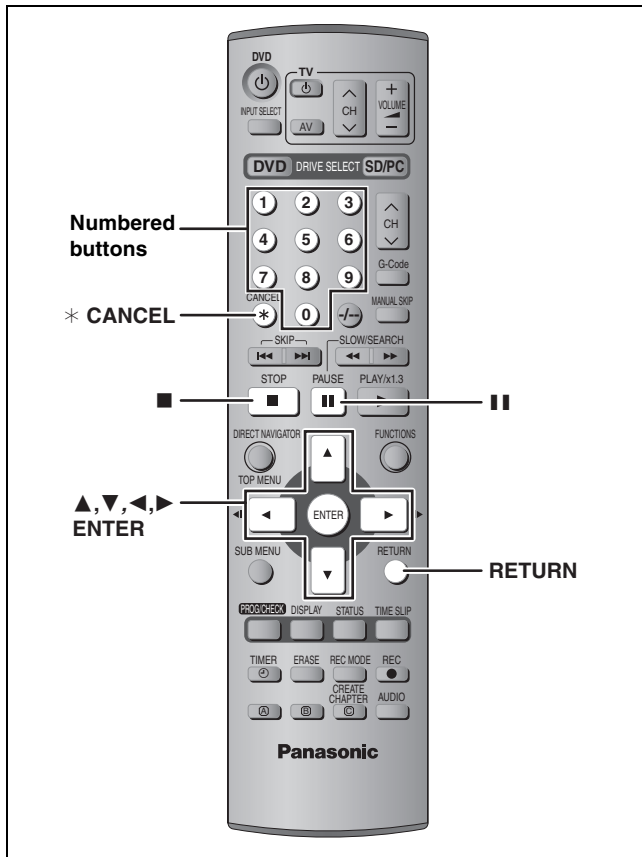

## 1 Show Enter Name screen.

### Title (timer recording)

Select "Programme Name" in step 3 on page 17, 18.

### Title

Select "Enter Name" in step 4 on page 28.

### Play list

Select "Enter Name" in step 4 on page 31.

### Disc

Select "Disc Name" in step 3 on page 36.

### Folder of still pictures

Select "Folder Name" in step 4 on page 32.

Name field: shows the text you have entered

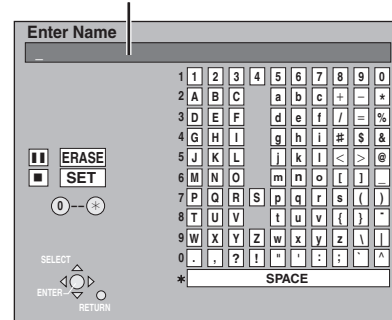

## 2 Press [▲, ▼, ◀, ▶] to select a character and press [ENTER].

Repeat this step to enter other characters.

### •To erase a character

Press [▲, ▼, ◀, ▶] to select the character in the name field and press [■].

### •Using the numbered buttons to enter characters

e.g., entering the letter "R"

- ① Press [7] to move to the 7th row.
- ② Press [7] twice to highlight "R".
- ③ Press [ENTER].

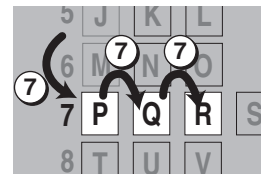

### •To enter a space

Press [\* CANCEL] and press [ENTER].

## 3 Press [■] (SET).

Returns to the previously displayed screen.

### To end partway

Press [RETURN].

Text is not saved.

### DVD-R

#### For your reference

If you enter a long name, only part of it is shown in the Top Menu after finalization (⇒ page 37). When entering a title name, the name that will appear in the Top Menu can be previewed in "Title on TOP MENU (DVD-R)" window.

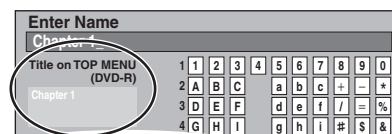

### RAM DVD-R SD PC

You can give names to recorded titles, etc.

The maximum number of characters:

RAM	Characters
Title	64 (44*)
Play list	64
Disc	64
Folder of still pictures	36
* Title name for timer recording	

DVD-R	Characters
Title	44
Disc	40

  

SD PC	Characters
Folder of still pictures	36

### Note

If a name is long, parts of it may not be shown in some screens.

# Changing the unit's settings

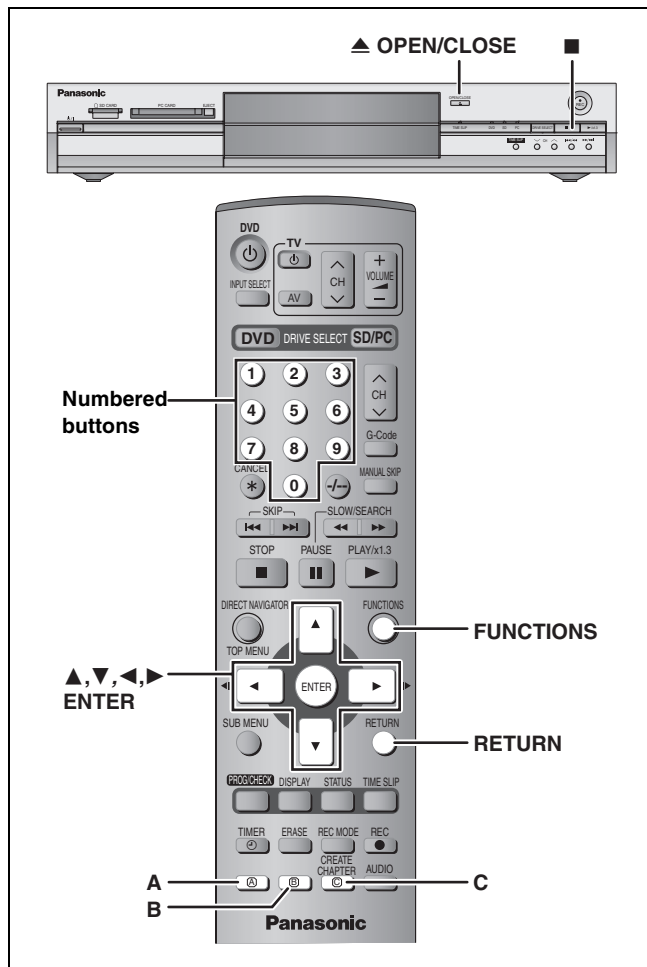

## Common procedures

- 1 While stopped  
Press [FUNCTIONS].
- 2 Press [▲, ▼, ◀, ▶] to select "SETUP" and press [ENTER].

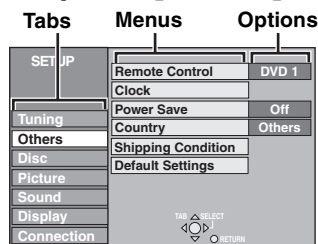

- 3 Press [▲, ▼] to select the tab and press [▶].
- 4 Press [▲, ▼] to select the menu and press [ENTER].
- 5 Press [▲, ▼] to select the option and press [ENTER].

### To exit the screen

Press [RETURN] several times.

### To return to the previous screen

Press [RETURN].



## Summary of settings

The settings remain intact even if you switch the unit to standby.

Tabs	Menus	Options (Underlined items are the factory presets.)
<b>Tuning</b>	<b>Manual</b> (⇒ page 42) <b>Auto-Setup Restart</b> (⇒ page 43)	
<b>Others</b>	<b>Remote Control</b> (⇒ page 11) <b>Clock</b> (⇒ page 43) <b>Power Save</b> • Refer to the following when "Power Save" is set to "On". – "FL Display" is automatically set to "Automatic" (⇒ page 41). – This function does not work in the timer recording standby mode. <b>Country</b> (⇒ page 9) <b>Shipping Condition</b> All the settings except for the ratings level, ratings password and time settings return to the factory preset. The timer recording programmes are also cancelled. <b>Default Settings</b> All the settings other than the programmed channels, time settings, disc language settings, ratings level, ratings password and remote control code return to the factory presets.	• <u>DVD 1</u> • DVD 2    • DVD 3  • On: Power consumption is minimized when the unit is turned to standby (⇒ page 45). • <u>Off</u>  • Australia    • New Zealand    • <u>Others</u>  • Yes • <u>No</u>  • Yes • <u>No</u>

Tabs	Menus	Options (Underlined items are the factory presets.)
Disc	<b>Language</b>	
	Choose the language for audio, subtitle and disc menus. <b>DVD-V</b>	
	<ul style="list-style-type: none"> <li>● Press [ENTER] to show the following settings.</li> <li>● Some discs start in a certain language despite any changes you make here.</li> <li>● Enter a code (⇒ page 42) with the numbered buttons when you select "Other ****".</li> </ul>	
	When the selected language is not available on the disc, the default language is played. There are discs where you can only switch the language from the menu screen (⇒ page 20).	
	<b>Soundtrack</b>	<ul style="list-style-type: none"> <li>● <u>English</u> ● French ● German ● Italian ● Spanish</li> <li>● Original: The original language of each disc will be selected.</li> <li>● Other ****</li> </ul>
	<b>Subtitle</b>	<ul style="list-style-type: none"> <li>● <u>Automatic</u>: If the language selected for "Soundtrack" is not available, subtitles of that language will automatically appear if available on that disc.</li> <li>● English ● French ● German ● Italian ● Spanish</li> <li>● Other ****</li> </ul>
	<b>Menus</b>	<ul style="list-style-type: none"> <li>● <u>English</u> ● French ● German ● Italian ● Spanish</li> <li>● Other ****</li> </ul>
	<b>Ratings</b>	<ul style="list-style-type: none"> <li>● <u>8 No Limit</u>: All DVD-Video can be played.</li> <li>● 1 to 7: Prohibits play of DVD-Video with corresponding ratings recorded on them.</li> <li>● 0 Lock All: Prohibits play of all DVD-Video.</li> </ul>
	Set a ratings level to limit DVD-Video play.	
	Follow the on-screen instructions. Enter a 4-digit password with the numbered buttons when the password screen is shown.	
<ul style="list-style-type: none"> <li>● Do not forget your password.</li> <li>● <u>Unlock Recorder</u> ● Change Password</li> <li>● Change Level ● Temporary Unlock</li> </ul>		
Picture	<b>Recording time in EP mode</b>	<ul style="list-style-type: none"> <li>● <u>EP (6Hour)</u>: You can record for 6 hours on an unused 4.7 GB disc.</li> <li>● <u>EP (8Hour)</u>: You can record for 8 hours on an unused 4.7 GB disc.</li> </ul>
	Select the maximum number of hours for recording in EP mode (⇒ page 15, Recording modes and approximate recording times).	
	<b>DVD-Audio Video mode Playback</b>	<ul style="list-style-type: none"> <li>● <u>On</u>: The setting returns to "Off" when you change the disc or turn the unit off.</li> <li>● <u>Off</u></li> </ul>
	Select "On" to play DVD-Video content on some DVD-Audio.	
	<b>Comb Filter</b>	<ul style="list-style-type: none"> <li>● <u>On</u>: Pictures become clear and vivid. Normally, use this setting.</li> <li>● <u>Off</u>: Select it when recording noisy pictures.</li> </ul>
	Select the picture sharpness when recording. The setting is fixed with "On" if you set "TV System" to "NTSC" (⇒ page 43).	
	<b>Hybrid VBR Resolution</b> (⇒ page 46, VBR)	<ul style="list-style-type: none"> <li>● <u>Automatic</u>: The resolution is automated to provide efficient recording with less block noise. <b>RAM</b></li> <li>● <u>Fixed</u>: The resolution is fixed to ensure that there is no loss of source picture resolution while recording.</li> </ul>
	<b>Still Mode</b>	<ul style="list-style-type: none"> <li>● <u>Automatic</u></li> <li>● <u>Field</u>: Select if jittering occurs when "Automatic" is selected.</li> <li>● <u>Frame</u>: Select if small text or fine patterns cannot be seen clearly when "Automatic" is selected.</li> </ul>
	Select the type of picture shown when you pause play (⇒ page 46, Frames and fields).	
	<b>Seamless Play</b>	<ul style="list-style-type: none"> <li>● <u>On</u>: The chapters in play lists are played seamlessly. This does not work when there are several audio types included on the play list and when using Quick View. Additionally, the positioning of chapter segments may change slightly.</li> <li>● <u>Off</u>: The points where chapters in play lists change are played accurately, but the picture may freeze for a moment.</li> </ul>
Selects the play mode for play list chapter segments.		
<b>AV-in NR</b>	<ul style="list-style-type: none"> <li>● <u>On</u>: Noise reduction works for input video.</li> <li>● <u>Off</u>: Noise reduction is off. Select when you want to record input as is.</li> </ul>	
Reduces video tape noise while transferring (dubbing).		



Tabs	Menus	Options (Underlined items are the factory presets.)
Sound	<b>PLAY × 1.3 &amp; Audio during Search</b> You may hear sound regardless of this setting with some discs.	<ul style="list-style-type: none"> <li>● <u>On</u>: Audio is heard during first level search forward.</li> <li>● <u>Off</u>: Audio is not heard during search. Quick View (⇒ page 21) does not work.</li> </ul>
	<b>Dynamic Range Compression <u>DVD-V</u></b> (Dolby Digital only) Change the dynamic range for late night viewing.	<ul style="list-style-type: none"> <li>● <u>On</u></li> <li>● <u>Off</u></li> </ul>
	<b>Bilingual Audio Selection <u>DVD-R</u></b> Select whether to record the main or secondary audio type when: –Recording or dubbing to a DVD-R. –Recording or dubbing sound in LPCM. (⇒ below, “Audio Mode for XP Recording”)	<ul style="list-style-type: none"> <li>● <u>M 1</u></li> <li>● <u>M 2</u></li> </ul> You cannot select this when recording from an external source onto DVD-R. Select the audio on the other equipment.
	<b>Digital Audio Output</b> Change the settings when you have connected equipment through this unit’s DIGITAL AUDIO OUT terminal (⇒ page 8). ● Press [ENTER] to show the following settings.	
	<b>PCM Down Conversion</b> Select how to output audio with a sampling frequency of 96 kHz or 88.2 kHz.	<ul style="list-style-type: none"> <li>● <u>On</u>: Signals are converted to 48 kHz or 44.1 kHz. (Choose when the connected equipment cannot process signals with a sampling frequency of 96 kHz or 88.2 kHz.)</li> <li>● <u>Off</u>: Signals are output as 96 kHz or 88.2 kHz. (Choose when the connected equipment can process signals with a sampling frequency of 96 kHz or 88.2 kHz.)</li> </ul> Signals are converted to 48 kHz or 44.1 kHz despite the above settings if the signals have a sampling frequency of over 96 kHz or 88.2 kHz, or the disc has copy protection.
	<b>Dolby Digital</b> Select how to output the signal, to output “Bitstream” so the connected equipment decodes the signal, or to decode on this unit and output the signal as “PCM” (2 channel). 	<ul style="list-style-type: none"> <li>● <u>Bitstream</u>: When connecting to equipment displaying the Dolby Digital logo.</li> <li>● <u>PCM</u>: When connecting to equipment not displaying the Dolby Digital logo.</li> </ul>
	<b>DTS</b> <b>Note</b>  Not making the proper settings may result in noise, possibly damage your hearing and speakers, and digital recording may not work properly.	<ul style="list-style-type: none"> <li>● <u>Bitstream</u>: When connecting to equipment displaying the DTS logo.</li> <li>● <u>PCM</u>: When connecting to equipment not displaying the DTS logo.</li> </ul>
	<b>MPEG</b>	<ul style="list-style-type: none"> <li>● <u>Bitstream</u>: When connected to equipment with a built-in MPEG decoder.</li> <li>● <u>PCM</u>: When connected to equipment without a built-in MPEG decoder.</li> </ul>
	<b>Audio Mode for XP Recording</b> Choose the audio type when recording with XP mode.	<ul style="list-style-type: none"> <li>● <u>Dolby Digital</u> (⇒ page 46)</li> <li>● <u>LPCM</u> (⇒ page 46) –The picture quality of LPCM recordings may be lower than that of normal XP mode recordings. –The audio recording becomes Dolby Digital even if you selected LPCM when using a recording mode other than XP. –When recording bilingual broadcast, select the type of audio in advance from “Bilingual Audio Selection” (⇒ above).</li> </ul>
	<b>Audio Mode for DV Input</b> You can select the kind of audio when recording from the unit’s DV input terminal (⇒ page 33).	<ul style="list-style-type: none"> <li>● <u>Stereo 1</u>: Records audio (L1, R1).</li> <li>● <u>Stereo 2</u>: Records added audio such as narration (L2, R2) subsequent to original recording.</li> <li>● <u>Mix</u>: Records both Stereo 1 and Stereo 2.</li> </ul> When recording bilingual broadcast to a DVD-R or recording in LPCM audio, select the type of audio in advance from “Bilingual Audio Selection” (⇒ above).
Display	<b>On-Screen Messages</b> Choose whether to show status messages automatically.	<ul style="list-style-type: none"> <li>● <u>Automatic</u></li> <li>● <u>Off</u></li> </ul>
	<b>Grey Background</b> Select “Off” if you do not want to have the unit show the grey background when reception is weak.	<ul style="list-style-type: none"> <li>● <u>On</u></li> <li>● <u>Off</u></li> </ul>
	<b>FL Display</b> Changes the brightness of the unit’s display. This setting is fixed with “Automatic” if you set “Power Save” (⇒ page 39) to “On”.	<ul style="list-style-type: none"> <li>● <u>Bright</u></li> <li>● <u>Dim</u></li> <li>● <u>Automatic</u>: The display turns dark during play, and reappears momentarily if a button is pressed. When the unit is turned off all displays disappear. While using this mode the standby power consumption can be reduced.</li> </ul>
Connection	<b>TV Aspect</b> (⇒ page 10)	<ul style="list-style-type: none"> <li>● <u>16:9</u></li> <li>● <u>4:3</u></li> <li>● <u>Letterbox</u></li> </ul>
	<b>Progressive</b> (⇒ page 10)	<ul style="list-style-type: none"> <li>● <u>On</u></li> <li>● <u>Off</u></li> </ul>
	<b>TV System</b> (⇒ page 43)	<ul style="list-style-type: none"> <li>● <u>PAL</u></li> <li>● <u>NTSC</u></li> </ul>
	<b>AV1 Output</b> Selects the output from the AV1 terminal. Select “RGB (without component)” for RGB output. Select “Video (with component)” or “S-Video (with component)” for component output.	<ul style="list-style-type: none"> <li>● <u>Video (with component)</u></li> <li>● <u>S-Video (with component)</u></li> <li>● <u>RGB (without component)</u></li> </ul>
	<b>AV2 Input</b> Set to “RGB (Not NTSC)” when receiving or recording RGB output video from external equipment.	<ul style="list-style-type: none"> <li>● <u>Video</u></li> <li>● <u>S-Video</u></li> <li>● <u>RGB (Not NTSC)</u></li> </ul>

Refer to the control reference on page 39.

## Tuning

- 1 While stopped  
Press [FUNCTIONS].
- 2 Press [▲, ▼, ◀, ▶] to select "SETUP" and press [ENTER].
- 3 Press [▲, ▼] to select "Tuning" and press [▶].

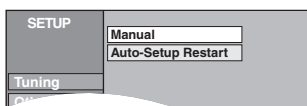

### Manual

You can add or delete channels, or change programme positions.

- 4 Press [▲, ▼] to select "Manual" and press [ENTER].

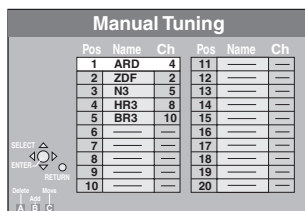

#### To delete a programme position

Press [▲, ▼, ◀, ▶] to select a programme position and press [A].

#### To add a blank programme position

Press [▲, ▼, ◀, ▶] to select a programme position and press [B].

#### To move a TV station to another programme position

- ① Press [▲, ▼, ◀, ▶] to select a programme position and press [C].
- ② Press [▲, ▼, ◀, ▶] to select the new programme position to which you want to assign the TV station and press [ENTER].

- To change the tuning settings for individual programme position

- 5 Press [▲, ▼, ◀, ▶] to select a programme position and press [ENTER].

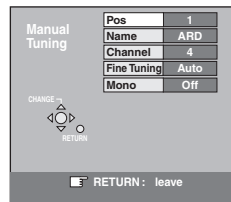

Press [▲, ▼] to select an item and press [▶].

<b>Pos</b>	<b>To change the programme position in which the TV stations are assigned</b> Press [▲, ▼] or numbered buttons to select the number of the desired programme position and press [ENTER].
<b>Name</b>	<b>To enter or change the name of a TV station</b> Press [▲, ▼, ◀, ▶] to enter station name and press [ENTER]. If the station name needs a blank space, select the blank between "Z" and "*".
<b>Channel</b>	<b>To enter newly available TV stations or change the channel number of an already tuned TV station</b> Press [▲, ▼] or the numbered buttons to enter the channel number of the desired TV station. Wait a few moments until the desired TV station has been tuned. After the desired TV station is tuned, press [ENTER].
<b>Fine Tuning</b>	<b>To obtain the best tuning condition</b> Press [▲, ▼] to adjust the best tuning condition and press [ENTER]. ● Press [▶] to return to "Auto".
<b>Mono</b>	<b>To select the type of sound to be recorded</b> Press [▲, ▼] to select "On" if the stereo sound is distorted due to inferior reception conditions, or if you want to record the normal (mono) sound during a stereo, bilingual or NICAM broadcast, and press [ENTER].

## Language code list

Input the code with the numbered buttons.

Abkhazian: 6566	Catalan: 6765	Gujarati: 7185	Lingala: 7678	Rhaeto-Romance: 8277	Tamil: 8465
Afar: 6565	Chinese: 9072	Hausa: 7265	Lithuanian: 7684	Romanian: 8279	Tatar: 8484
Afrikaans: 6570	Corsican: 6779	Hebrew: 7387	Macedonian: 7775	Russian: 8285	Telugu: 8469
Albanian: 8381	Croatian: 7282	Hindi: 7273	Malagasy: 7771	Samoan: 8377	Thai: 8472
Ameharic: 6577	Czech: 6783	Hungarian: 7285	Malay: 7783	Sanskrit: 8365	Tibetan: 6679
Arabic: 6582	Danish: 6865	Icelandic: 7383	Malayalam: 7776	Scots Gaelic: 7168	Tigrinya: 8473
Armenian: 7289	Dutch: 7876	Indonesian: 7378	Maltese: 7784	Serbian: 8382	Tonga: 8479
Assamese: 6583	English: 6978	Interlingua: 7365	Maori: 7773	Serbo-Croatian: 8372	Turkish: 8482
Aymara: 6588	Esperanto: 6979	Irish: 7165	Marathi: 7782	Shona: 8378	Turkmen: 8475
Azerbaijani: 6590	Estonian: 6984	Italian: 7384	Moldavian: 7779	Sindhi: 8368	Twi: 8487
Bashkir: 6665	Faroese: 7079	Japanese: 7465	Mongolian: 7778	Singhalese: 8373	Ukrainian: 8575
Basque: 6985	Fiji: 7074	Javanese: 7487	Nauru: 7865	Slovak: 8375	Urdu: 8582
Bengali; Bangla: 6678	Finnish: 7073	Kannada: 7578	Nepali: 7869	Slovenian: 8376	Uzbek: 8590
Bhutani: 6890	French: 7082	Kashmiri: 7583	Norwegian: 7879	Somali: 8379	Vietnamese: 8673
Bihari: 6672	Frisian: 7089	Kazakh: 7575	Oriya: 7982	Spanish: 6983	Volapük: 8679
Breton: 6682	Galician: 7176	Kirghiz: 7589	Pashto, Pushto: 8083	Sundanese: 8385	Welsh: 6789
Bulgarian: 6671	Georgian: 7565	Korean: 7579	Persian: 7065	Swahili: 8387	Wolof: 8779
Burmese: 7789	German: 6869	Kurdish: 7585	Polish: 8076	Swedish: 8386	Xhosa: 8872
Byelorussian: 6669	Greek: 6976	Laotian: 7679	Portuguese: 8084	Tagalog: 8476	Yiddish: 7473
Cambodian: 7577	Greenlandic: 7576	Latin: 7665	Punjabi: 8065	Tajik: 8471	Yoruba: 8979
	Guarani: 7178	Latvian, Lettish: 7686	Quechua: 8185		Zulu: 9085

## Auto-Setup Restart

You can restart auto channel setting if Auto-Setup (⇒ page 9) fails for some reason.

After performing steps 1–3 (⇒ page 42)

- Press [**▲**, **▼**] to select “Auto-Setup Restart” and press [ENTER].  
The confirmation screen appears.
- Press [**◀**, **▶**] to select “Yes” and press [ENTER].  
The country setting menu appears.
- Press [**◀**, **▶**] to select the country and press [ENTER].  
Auto-Setup starts.

**To exit the screen**

Press [RETURN] several times.

**To return to the previous screen**

Press [RETURN].

### List of TV Reception Channels

Country	VHF	UHF	CATV
Australia	0–12	28–69	45–470 MHz
New Zealand	1–11	21–69	44–470 MHz

## TV System

If pictures are distorted, change the settings to match the equipment you are connecting with.

- While stopped  
Press [FUNCTIONS].
- Press [**▲**, **▼**, **◀**, **▶**] to select “SETUP” and press [ENTER].
- Press [**▲**, **▼**] to select “Connection” and press [**▶**].
- Press [**▲**, **▼**] to select “TV System” and press [ENTER].
- Press [**▲**, **▼**] to select the TV system and press [ENTER].

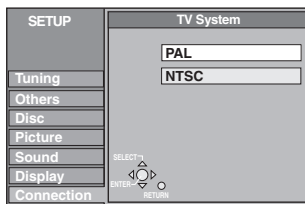

- **PAL** (factory preset)
  - Select when connecting to a PAL or Multi-system television. Titles recorded using NTSC are played as PAL 60.
  - Select to record television programmes and PAL input from other equipment.
- **NTSC**
  - Select when connecting to a NTSC television. Television programmes cannot be recorded properly.
  - Select to record NTSC input from other equipment.

- Press [**◀**, **▶**] to select “Yes” and press [ENTER].

**To exit the screen**

Press [RETURN] several times.

**To return to the previous screen**

Press [RETURN].

### ■ To change the setting all at once (PAL ↔ NTSC)

While stopped, keep pressing [■] and [**▲** OPEN/CLOSE] on the main unit for 5 or more seconds.

## Clock settings

In the case of a power failure, the clock setting remains in memory for approximately 60 minutes.

- While stopped  
Press [FUNCTIONS].
- Press [**▲**, **▼**, **◀**, **▶**] to select “SETUP” and press [ENTER].
- Press [**▲**, **▼**] to select the “Others” and press [**▶**].
- Press [**▲**, **▼**] to select “Clock” and press [ENTER].

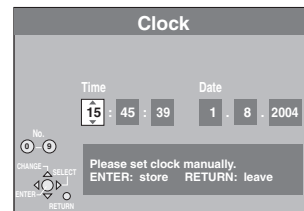

- Press [**◀**, **▶**] to select the item you want to change.  
The items change as follows:  
Hour ↔ Minute ↔ Second ↔ Day ↔ Month ↔ Year
- Press [**▲**, **▼**] to change the setting.  
You can also use the numbered buttons for setting.
- Press [ENTER] when you have finished the settings.  
The clock starts.

**To exit the screen**

Press [RETURN] several times.

**To return to the previous screen**

Press [RETURN].

## Child Lock

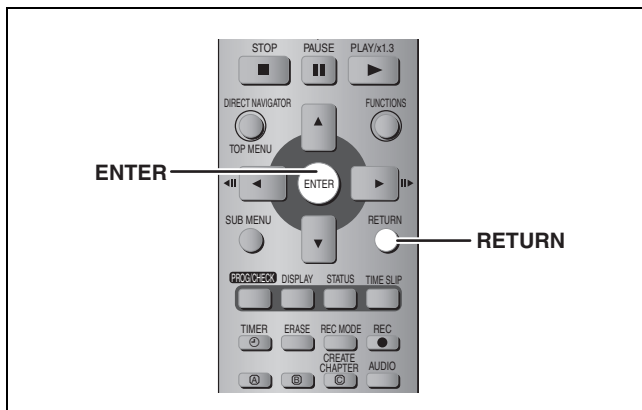

The Child Lock deactivates all buttons on the unit and remote control. Use it to prevent other people from operating the unit.

**Press and hold [ENTER] and [RETURN] simultaneously until “X HOLD” appears on the unit’s display.**



If you press a button while the Child Lock is on, “X HOLD” appears on the unit’s display and operation is impossible.

### To cancel the Child Lock

Press and hold [ENTER] and [RETURN] simultaneously until “X HOLD” disappears.

## Maintenance/Disc and card handling

### Unit care

The precision parts in this unit are readily affected by the environment, especially temperature, humidity, and dust. Cigarette smoke also can cause malfunction or breakdown.

To clean this unit, wipe with a soft, dry cloth.

- Never use alcohol, paint thinner or benzene to clean this unit.
- Before using chemically treated cloth, read the instructions that came with the cloth carefully.

**Observe the following points to ensure continued listening and viewing pleasure.**

Dust and dirt may adhere to the unit’s lens over time, making it impossible to record or play discs.

Use the **DVD-RAM/PD lens cleaner (LF-K123LCA1, where available)** about once every year, depending on frequency of use and the operating environment. Read the lens cleaner’s instructions carefully before use.

### Disc and card handling

#### ■ How to hold a disc or card

Do not touch the recorded surface or the terminal surface.

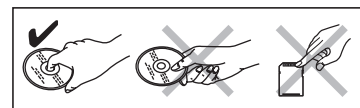

#### ■ If there is dirt or condensation on the disc

##### RAM DVD-R

- Clean with an optional DVD-RAM/PD disc cleaner (LF-K200DCA1, where available).
- Do not use cleaners for CDs or cloths.

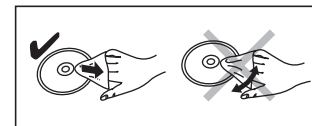

##### DVD-A DVD-V VCD CD

Wipe with a damp cloth and then wipe dry.

#### ■ Handling precautions

- Do not attach labels or stickers to discs. (This may cause disc warping and un-balanced rotation, rendering it unusable.)
- Do not write on the label side with a ball-point pen or other writing instrument.
- Do not use record cleaning sprays, benzene, thinner, static electricity prevention liquids or any other solvent.
- Do not use scratch-proof protectors or covers.
- Do not expose the terminals of the card to water, garbage or other strange things.
- Do not use the following discs:
  - Discs with exposed adhesive from removed stickers or labels (rented discs etc).
  - Discs that are badly warped or cracked.
  - Irregularly shaped discs, such as heart shapes.

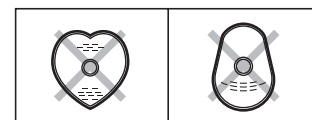

- Do not place in the following areas:
  - In direct sunlight.
  - In very dusty or humid areas.
  - Near a heater.
  - Where static electricity or electromagnetic waves occur.

# Specifications

**Recording system** DVD Video Recording format (DVD-RAM),  
DVD-Video format (DVD-R)

## Recordable discs

DVD-RAM: 12 cm 4.7 GB, 12 cm 9.4 GB, 8 cm 2.8 GB  
12 cm 4.7 GB (Ver. 2.1/3×-SPEED DVD-RAM Revision 1.0)  
DVD-R: 12 cm 4.7 GB, 8 cm 1.4 GB (for General Ver. 2.0)  
12 cm 4.7 GB (for General Ver. 2.0/4×-SPEED DVD-R Revision 1.0)

## Recording time

Maximum 8 hours (with 4.7 GB disc)  
XP: Approx. 1 hour, SP: Approx. 2 hours  
LP: Approx. 4 hours, EP: Approx. 6 hours/8 hours

## Playable discs

DVD-RAM: 12 cm 4.7 GB, 12 cm 9.4 GB, 8 cm 2.8 GB  
12 cm 4.7 GB (Ver. 2.1/3×-SPEED DVD-RAM Revision 1.0)  
DVD-R: 12 cm 4.7 GB, 8 cm 1.4 GB (for General Ver. 2.0)  
12 cm 4.7 GB (for General Ver. 2.0/4×-SPEED DVD-R Revision 1.0)  
DVD-Video, DVD-Audio, Video CD, CD-Audio (CD-DA)  
CD-R/RW (MP3, CD-DA, Video CD formatted discs)

## Drive unit

High Speed Drive (correspond to 4 times speed with  
DVD-R disc and 3 times speed with DVD-RAM disc.)

## LASER specification

Class I LASER Product

Wave length: 795 nm, 658 nm

Laser power:

No hazardous radiation is emitted with the safety protection

## Audio

Recording system: Dolby Digital 2ch, Linear PCM (XP mode, 2ch)  
Audio in: AV1/AV2 (21 pin), AV3/AV4 (pin jack)  
Input level: Standard: 0.5 Vrms, Full scale: 2.0 Vrms at 1 kHz  
Input impedance: More than 10 kΩ  
Audio out: AV1/AV2 (21 pin), Audio Out (pin jack)  
Output level: Standard: 0.5 Vrms, Full scale: 2.0 Vrms at 1 kHz  
Output impedance: Less than 1 kΩ  
Digital audio out: Optical terminal (PCM, Dolby Digital, DTS, MPEG)

## Television system

Tuner system	Channel coverage
PAL-B Australia	VHF: CH 0-12 UHF: CH 28-69 CATV: 45 MHz-470 MHz
PAL-BG New Zealand	VHF: CH 1-11 UHF: CH 21-69 CATV: 44 MHz-470 MHz

RF converter output:

Not provided

## Video

Video system:

PAL colour signal, 625 lines, 50 fields  
NTSC colour signal, 525 lines, 60 fields  
MPEG2 (Hybrid VBR)

Recording system:

Video in (SECAM/PAL/NTSC):

AV1/AV2 (21 pin), AV3/AV4 (pin jack) 1 Vp-p 75 Ω, termination

S-Video in (SECAM/PAL/NTSC):

AV2 (21 pin), AV3/AV4 (S terminal) 1 Vp-p 75 Ω, termination

RGB in (PAL): AV2 (21 pin) 0.7 Vp-p (PAL) 75 Ω, termination

Video out (PAL/NTSC):

AV1/AV2 (21 pin), Video Out (pin jack) 1 Vp-p 75 Ω, termination

S-Video out (PAL/NTSC):

AV1 (21 pin), S-Video Out (S terminal) 1 Vp-p 75 Ω, termination

RGB out (PAL/NTSC): AV1 (21 pin) 0.7 Vp-p (PAL) 75 Ω, termination

Component video output (NTSC 480P/480I, PAL 576P/576I)

Y: 1.0 Vp-p 75 Ω, termination

Pb: 0.7 Vp-p 75 Ω, termination

Pr: 0.7 Vp-p 75 Ω, termination

## DV input (PAL/NTSC)

IEEE 1394 Standard, 4 pin

## SD/PC card slot

SD Memory Card slot: 1 pc.

PC Card slot (Type II): 1 pc.

Still picture (JPEG, TIFF)

Compatible media (SD card slot):

SD Memory Card, MultiMediaCard

Compatible media (PC card slot):

A PC card adaptor conforming to PC card standards,

ATA Flash PC Card,

PC card adaptor (SD Memory Card, xD-Picture Card,

Microdrive, MultiMediaCard, CompactFlash,

SmartMedia, MEMORYSTICK), Mobile hard disk

Format:

FAT12, FAT16

Image file format:

JPEG conforming to DCF

(Design rule for Camera File system),

(Sub sampling 4:2:2 or 4:2:0),

TIFF (Uncompressed RGB chunky),

DPOF compatible

Number of pixels:

34×34 to 6144×4096

Thawing time:

Approx. 7 sec. (2 M pixels)

## Others

Region code:

# 4

Operating temperature:

5-40 °C

Operating humidity range:

10-80 % RH (no condensation)

Power supply:

AC 220-240 V, 50 Hz

Power consumption:

32 W

Dimensions (W×D×H):

Approx. 430 mm×274 mm×79 mm

Mass:

Approx. 3.6 kg

## Power consumption in standby mode:

Approx. 3 W (Power Save mode)

## Note

Specifications are subject to change without notice.

Mass and dimensions are approximate.

# Safety precautions

## Placement

Set the unit up on an even surface away from direct sunlight, high temperatures, high humidity, and excessive vibration. These conditions can damage the cabinet and other components, thereby shortening the unit's service life.

Do not place heavy items on the unit.

## Voltage

Do not use high voltage power sources. This can overload the unit and cause a fire.

Do not use a DC power source. Check the source carefully when setting the unit up on a ship or other place where DC is used.

## AC mains lead protection

Ensure the AC mains lead is connected correctly and not damaged. Poor connection and lead damage can cause fire or electric shock. Do not pull, bend, or place heavy items on the lead.

Grasp the plug firmly when unplugging the lead. Pulling the AC mains lead can cause electric shock.

Do not handle the plug with wet hands. This can cause electric shock.

## Foreign matter

Do not let metal objects fall inside the unit. This can cause electric shock or malfunction.

Do not let liquids get into the unit. This can cause electric shock or malfunction. If this occurs, immediately disconnect the unit from the power supply and contact your dealer.

Do not spray insecticides onto or into the unit. They contain flammable gases which can ignite if sprayed into the unit.

## Service

Do not attempt to repair this unit by yourself. If sound is interrupted, indicators fail to light, smoke appears, or any other problem that is not covered in these instructions occurs, disconnect the AC mains lead and contact your dealer or an authorized service center. Electric shock or damage to the unit can occur if the unit is repaired, disassembled or reconstructed by unqualified persons.

Extend operating life by disconnecting the unit from the power source if it is not to be used for a long time.

## Bitstream

This is the digital form of multi-channel audio data (e.g., 5.1 channel) before it is decoded into its various channels.

## CPRM (Content Protection for Recordable Media)

CPRM is technology used to protect broadcasts that are allowed to be recorded only once. Such broadcasts can be recorded only with CPRM compatible recorders and discs.

## Dolby Digital

This is a method of coding digital signals developed by Dolby Laboratories. Apart from stereo (2-channel) audio, these signals can also be multi-channel audio. A large amount of audio information can be recorded on one disc using this method. When recording on this unit Dolby Digital (2 channel) is the default audio.

## Down-mixing

This is the process of remixing the multi-channel audio found on some discs into two channels. It is useful when you want to listen to the 5.1-channel audio recorded on DVDs through your television's speakers. Some discs prohibit down-mixing and this unit can then only output the front two channels.

## DPOF (Digital Print Order Format)

DPOF is the standard printing format for still picture data taken by a digital camera, etc. It is used for automatic printing at a photo developing store or on your home printer.

## Drive

In the instance of this unit, this refers to the disc (DVD), SD card (SD) and PC card (PC). These perform the reading and writing of data.

## DTS (Digital Theater Systems)

This surround system is used in many movie theaters. There is good separation between the channels, so realistic sound effects are possible.

## Dynamic range

Dynamic range is the difference between the lowest level of sound that can be heard above the noise of the equipment and the highest level of sound before distortion occurs.

Dynamic range compression means reducing the gap between the loudest and softest sounds. This means you can listen at low volumes but still hear dialogue clearly.

## Film and video

DVD-Videos are recorded using either film or video. This unit can determine which type has been used, then uses the most suitable method of progressive output.

For PAL

Film is 25 frames per second.

Video is 50 fields per second (two fields making up one frame).

For NTSC

Film is 24 or 30 frames per second, with motion picture film generally being 24 frames per second.

Video is 60 fields per second (two fields making up one frame).

## Finalize

A process that makes play of a recorded CD-R, CD-RW, DVD-R, etc. possible on equipment that can play such media. You can finalize DVD-R on this unit.

After finalizing, the disc becomes play-only and you can no longer record or edit.

## Folder

This is a place on the DVD-RAM or memory card where groups of data are stored together. In the case of this unit, it refers to the place where still pictures (JPEG, TIFF) are stored.

## Formatting

Formatting is the process of making media such as DVD-RAM recordable on recording equipment.

You can format the DVD-RAM and memory cards on this unit. Formatting erases irrevocably all contents.

## Frames and fields

Frames refer to the single images that constitute the video you see on your television. Each frame consists of two fields.

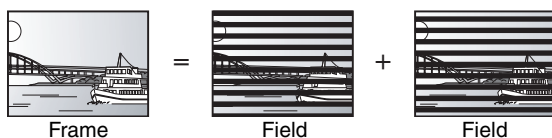

- A frame still shows two fields, so there may be some blurring, but picture quality is generally better.
- A field still shows less picture information so it may be rougher, but there is no blurring.

## JPEG (Joint Photographic Experts Group)

This is a system used for compressing/decoding colour still pictures. If you select JPEG as the storage system on digital cameras etc., the data will be compressed to 1/10–1/100 of its original size. The feature of JPEG is less deterioration in picture quality considering the degree of compression.

## LPCM (Linear PCM)

These are uncompressed digital signals, similar to those found on CDs. LPCM sound is available when recording in XP mode.

## MP3 (MPEG Audio Layer 3)

An audio compression method that compresses audio to approximately one tenth of its size without any considerable loss of audio quality. You can play MP3 you have recorded onto CD-R and CD-RW.

## Pan&Scan/Letterbox

In general, DVD-Video are produced with the intention that they be viewed on a widescreen television (16:9 aspect ratio), so images often don't fit regular (4:3 aspect ratio) televisions. Two styles of picture, "Pan & Scan" and "Letterbox", deal with this problem.

Pan & Scan: The sides are cut off so the picture fills the screen.



Letterbox: Black bands appear at the top and bottom of the picture so the picture itself appears in an aspect ratio of 16:9.



## Playback control (PBC)

If a Video CD has playback control, you can select scenes and information with menus.

(This unit is compatible with version 2.0 and 1.1.)

## Progressive/Interlace

The PAL video signal standard has 576 (or 625) interlaced (I) scan lines, whereas progressive scanning, called 576P (or 625P), uses twice the number of scan lines. For the NTSC standard, these are called 480I (or 525I) and 480P (or 525P) respectively.

Using progressive output, you can enjoy the high-resolution video recorded on media such as DVD-Video.

Your television must be compatible to enjoy progressive video.

## Protection

You can prevent accidental erasure by setting writing protection or erasure protection.

## Sampling frequency

Sampling is the process of converting the heights of sound wave (analog signal) samples taken at set periods into digits (digital encoding). Sampling frequency is the number of samples taken per second, so larger numbers mean more faithful reproduction of the original sound.

## TIFF (Tag Image File Format)

This is a system used for compressing/decoding colour still pictures. A common format for storing high quality images on digital cameras and other devices.

## Thumbnail

This refers to a miniature representation of a picture used to display multiple pictures in the form of a list.

## VBR (Variable bitrate)

This is a method of video recording that adjusts the bit rate according to video signal.

# Frequently asked questions

Set up		Page
What equipment is necessary to play multi channel surround sound?	<ul style="list-style-type: none"> <li>●DVD-Video: You can play DVD-Video multi channel surround by digitally connecting an amplifier equipped with a Dolby Digital, DTS or MPEG decoder.</li> <li>●DVD-Audio: This unit plays DVD-Audio in 2 channels. You cannot play multi channel surround sound.</li> </ul>	8 —
Are the headphones and speakers directly connected to the unit?	<ul style="list-style-type: none"> <li>●You cannot directly connect to the unit. Connect through the amplifier etc.</li> </ul>	8
The television has both S-VIDEO IN terminal and COMPONENT VIDEO IN terminals. Which terminal should I connect with?	<ul style="list-style-type: none"> <li>●Connecting with the component video out terminal provides a more vivid picture compared to connecting with the S-Video out terminal. If you have an LCD/plasma television or LCD projector compatible with progressive scan, connect through the component video terminals for high-quality progressive video. If you have a CRT television or a multi system television using PAL mode that is compatible with progressive scan, we cannot recommend progressive output as some flickering can occur.</li> </ul>	7
Is my television progressive output compatible?	<ul style="list-style-type: none"> <li>●All Panasonic televisions that have 576P (625P)/480P (525P) input terminals are compatible. Consult the manufacturer if you have another brand of television.</li> </ul>	—
Disc		
Can I play DVD-Video, DVD-Audio and Video CDs bought in another country?	<ul style="list-style-type: none"> <li>●You cannot play DVD-Video if their region number does not include "4" or "ALL".</li> </ul>	Cover
Can a DVD-Video that does not have a region number be played?	<ul style="list-style-type: none"> <li>●The DVD-Video region number indicates the disc conforms to a standard. You cannot play discs that do not have a region number.</li> </ul>	—
Please tell me about DVD-R and DVD-RW compatibility with this unit.	<ul style="list-style-type: none"> <li>●This unit records and plays DVD-R. However, you cannot record onto DVD-R discs that are finalized.</li> <li>●This unit also records and plays high speed recording compatible discs.</li> <li>●This unit does not record or play DVD-RW.</li> </ul>	— — —
Please tell me about CD-R and CD-RW compatibility with this unit.	<ul style="list-style-type: none"> <li>●This unit plays CD-R/CD-RW discs (audio recording discs) which have been recorded under one of the following standards: CD-DA, MP3 and Video CD. Close the session or finalize the disc after recording.</li> <li>●You cannot write to a CD-R or CD-RW with this unit.</li> </ul>	12, 23 —
Recording		
Can I record from a commercially purchased video cassette or DVD?	<ul style="list-style-type: none"> <li>●Most commercially sold video cassettes and DVD are copy protected; therefore, recording is usually not possible.</li> </ul>	—
Can a DVD-R recorded on this unit be played on other equipment?	<ul style="list-style-type: none"> <li>●You can play on DVD-R compatible players after finalizing the disc on this unit; however, due to the condition of the recording, play may not be possible.</li> </ul>	37
How many times can I write to a DVD-RAM disc?	<ul style="list-style-type: none"> <li>●You can write to the disc approximately 100,000 times depending upon the conditions of use.</li> </ul>	—
Can I record digital audio signals using this unit?	<ul style="list-style-type: none"> <li>●You cannot record digital signals. The digital audio terminals on this unit are for output only. (The audio recorded using the DV automatic recording function from a digital video camcorder, for example, is recorded digitally.)</li> </ul>	—
Can a digital audio signal from this unit be recorded to other equipment?	<ul style="list-style-type: none"> <li>●You can record if using the PCM signal. When recording DVD, change the "Digital Audio Output" settings to the following in the SETUP menu. –PCM Down Conversion: On –Dolby Digital/DTS/MPEG: PCM However, only as long as digital recording from the disc is permitted and the recording equipment is compatible with a sampling frequency of 48 kHz.</li> <li>●You cannot record MP3 signals.</li> </ul>	41 —
Can I switch to bilingual broadcast during recording?	<ul style="list-style-type: none"> <li>●With DVD-RAM, you can. Just press [AUDIO].</li> <li>●With DVD-R, you cannot. Change before recording with "Bilingual Audio Selection" in the SETUP menu.</li> </ul>	22 41

## On the television

		Page
Cannot finish recording completely.	<ul style="list-style-type: none"> <li>The programme was copy-protected.</li> <li>The disc may be full.</li> </ul>	—
Cannot playback this title. TV system is different from the setting. To playback this title, please change the TV System in SETUP.	<ul style="list-style-type: none"> <li>You tried to play a title recorded using a different encoding system from that of the TV system currently selected on the unit. Alter the "TV System" setting on this unit to suit.</li> </ul>	43
Cannot record on the disc.	<ul style="list-style-type: none"> <li>The disc may be dirty or scratched.</li> </ul>	44
Please check the disc.	<ul style="list-style-type: none"> <li>You cannot format a Microdrive or mobile hard disk on this unit.</li> </ul>	—
Unable to format.		
Cannot play on this unit.	<ul style="list-style-type: none"> <li>You tried to play a non-compatible image.</li> <li>Turn the unit off and re-insert the card.</li> </ul>	24 24
Cannot record. Disc is full.	<ul style="list-style-type: none"> <li>Create space by erasing any unnecessary titles. <b>RAM</b> (Even if you erase recorded content from the DVD-R, there is no increase in disc space.)</li> <li>Use a new disc.</li> </ul>	22, 29, 36, 37
Cannot record. Maximum number of titles exceeded		—
Error has occurred. Please press ENTER.	<ul style="list-style-type: none"> <li>Press [ENTER] to start recovery process. You cannot operate the unit while it is recovering ("SELF CHECK" appears on the unit's display).</li> </ul>	—
No Disc	<ul style="list-style-type: none"> <li>The disc may be upside down.</li> </ul>	—
No folders.	<ul style="list-style-type: none"> <li>There is no compatible folder in this unit.</li> </ul>	13
No PC CARD No SD CARD No valid PC card. No valid SD card.	<ul style="list-style-type: none"> <li>The card is not inserted. If this message is displayed with a compatible card already inserted, turn off the unit, remove and then re-insert the card.</li> <li>The card inserted is not compatible or the card format does not match.</li> </ul>	24 13
Not enough space on dubbing destination.	<ul style="list-style-type: none"> <li>Create space by erasing any unnecessary items.</li> </ul>	22, 25, 29, 32, 36, 37
Please change the disc.	<ul style="list-style-type: none"> <li>There may be a problem with the disc. Press [▲ OPEN/CLOSE] on the main unit to remove it and check it for scratches or dirt. (The unit turns off automatically after you open the tray.)</li> </ul>	44
This is a non-recordable disc.	<ul style="list-style-type: none"> <li>The unit cannot record on the disc you inserted. Insert a DVD-RAM or unformatted DVD-R.</li> <li>You inserted an unformatted DVD-RAM. Format the disc with this unit.</li> </ul>	— 37
This disc is not properly formatted. Formatting is necessary using DISC MANAGEMENT.		
⊘	<ul style="list-style-type: none"> <li>The operation is prohibited by the unit or disc.</li> </ul>	—

## On the unit's display

HARD ERR	<ul style="list-style-type: none"> <li>If there is no change after turning the unit on and off, consult the dealer where the unit was purchased.</li> </ul>	—
NO READ	<ul style="list-style-type: none"> <li>The disc is dirty or badly scratched. The unit cannot record, play, or edit.</li> <li>You have used a DVD-RAM/PD lens cleaner and it has finished. Press [▲ OPEN/CLOSE] on the main unit to eject the disc.</li> </ul>	44 —
PROG FULL	<ul style="list-style-type: none"> <li>There are already 16 timer programmes. Delete unnecessary timer programmes.</li> </ul>	19
REMOTE DVD □ ("□" stands for a number.)	<ul style="list-style-type: none"> <li>The remote control and main unit are using different codes. Change the code on the remote control.</li> </ul>  <p>Press and hold [ENTER] and the indicated number button at the same time for more than 2 seconds.</p>	11
SELF CHECK	<ul style="list-style-type: none"> <li>The unit is starting up. Wait until the message disappears.</li> </ul>	—
U14	<ul style="list-style-type: none"> <li>The unit is hot. The unit switches to standby for safety reasons. Wait for about 30 minutes until the message disappears. Select a position with good ventilation when installing the unit. Do not block the cooling fan on the rear of the unit.</li> </ul>	—
U99	<ul style="list-style-type: none"> <li>The unit fails to operate properly. Press [⏻/I] on the main unit to switch the unit to standby. Now press [⏻/I] on the main unit again to turn the unit on.</li> </ul>	—
UNSUPPORT	<ul style="list-style-type: none"> <li>You have inserted a disc the unit cannot play or record on.</li> </ul>	12
X HOLD	<ul style="list-style-type: none"> <li>The Child Lock function is activated. Press and hold [ENTER] and [RETURN] simultaneously until "X HOLD" disappears.</li> </ul>	44



# Troubleshooting guide

Before requesting service, make the following checks. If you are in doubt about some of the check points, or if the remedies indicated in the chart do not solve the problem, consult your dealer for instructions.

The following do not indicate a problem with this unit:

- |  |   |
|--|---|
| <ul style="list-style-type: none"> <li>● Regular disc rotating sounds. The sound of the disc rotating may become louder especially when finalizing a DVD-R.</li> </ul> | <ul style="list-style-type: none"> <li>● Poor reception due to atmospheric conditions.</li> <li>● Image disturbance during search.</li> </ul> |
|--|---|

## Power

		Page
<b>No power.</b> <b>Unit does not turn on pressing</b> [⏻ DVD].	<ul style="list-style-type: none"> <li>● Insert the AC mains lead securely into a known active AC mains socket.</li> </ul>	7
<b>The unit switches to standby mode.</b>	<ul style="list-style-type: none"> <li>● One of the unit's safety devices is activated. Press [⏻/I] on the main unit to turn the unit on.</li> </ul>	—

## Displays

<b>The display is dim.</b>	<ul style="list-style-type: none"> <li>● Change "FL Display" in the SETUP menu.</li> </ul>	41
<b>"0:00" is flashing on the unit's display.</b>	<ul style="list-style-type: none"> <li>● Set the clock.</li> </ul>	43
<b>The time recorded on the disc and the available time shown do not add up.</b> <b>The play time shown for MP3 does not agree with the actual time.</b>	<ul style="list-style-type: none"> <li>● Times shown may disagree with actual times.</li> <li>● More disc space than the actual recording time is used after recording or editing the DVD-R 200 times or more.</li> <li>● While searching, the elapsed time may not display correctly.</li> <li>● Even if you erase recorded content from the DVD-R, there is no increase in disc space.</li> </ul>	— — — —
<b>Compared to the actual recorded time, the remaining time displayed is less.</b> <b>(Only when recording in NTSC)</b>	<ul style="list-style-type: none"> <li>● The displayed recording/play time is converted from the number of frames at 29.97 frames (equal to 0.999 seconds) to one second. There will be a slight difference between the time displayed and the actual elapsed time (e.g., actual one-hour elapsed time may display as approximately 59 minutes 56 seconds). This does not affect the recording.</li> </ul>	—

## TV screen and video

<b>Television reception worsens after connecting the unit.</b>	<ul style="list-style-type: none"> <li>● This can occur because the signals are being divided between the unit and other equipment. It can be solved by using a signal booster, available from audio-visual suppliers.</li> </ul>	—
<b>Status messages do not appear.</b>	<ul style="list-style-type: none"> <li>● Select "Automatic" in "On-Screen Messages" in the SETUP menu.</li> </ul>	41
<b>The grey background does not appear.</b>	<ul style="list-style-type: none"> <li>● Select "On" in "Grey Background" in the SETUP menu.</li> </ul>	41
<b>The 4:3 aspect ratio picture expands left and right.</b>	<ul style="list-style-type: none"> <li>● Use the television to change the aspect. If your television does not have that function, set "Progressive" in the Picture menu to "OFF".</li> </ul>	27
<b>Screen size is wrong.</b>	<ul style="list-style-type: none"> <li>● Check the settings for "TV Aspect" in the SETUP menu.</li> </ul>	10
<b>There is a lot of after-image when playing video.</b>	<ul style="list-style-type: none"> <li>● Set "Playback NR" in the Picture menu to "OFF".</li> </ul>	27
<b>When playing DVD-Video using progressive output, one part of the picture momentarily appears to be doubled up.</b>	<ul style="list-style-type: none"> <li>● Set "Progressive" in the Picture menu to "OFF". This problem is caused by the editing method or material used on DVD-Video, but should be corrected if you use interlace output.</li> </ul>	27
<b>There is no apparent change in picture quality when adjusted with the Picture menu in the on-screen menus.</b>	<ul style="list-style-type: none"> <li>● The effect is less perceivable with some types of video.</li> </ul>	—
<b>The images from this unit do not appear on the television.</b>	<ul style="list-style-type: none"> <li>● Make sure that the television is connected to the VIDEO OUT terminal, S-VIDEO OUT terminal or COMPONENT VIDEO OUT terminals on this unit.</li> </ul>	7
<b>Picture is distorted.</b>	<ul style="list-style-type: none"> <li>● Make sure that the television's input setting (e.g., AV 1) is correct.</li> <li>● The television isn't compatible with progressive signals. Press and hold [■] and [TIME SLIP] on the main unit at the same time for about 5 seconds. The setting will change to interlace.</li> <li>● The unit's "TV System" setting differs from the TV system used by the disc now playing. While stopped, keep pressing [■] and [▲ OPEN/CLOSE] on the main unit for 5 or more seconds. The system switches from PAL to NTSC or vice versa.</li> </ul>	— — 43

## Sound

<b>No sound.</b> <b>Low volume.</b> <b>Distorted sound.</b> <b>Cannot hear the desired audio type.</b>	<ul style="list-style-type: none"> <li>● Check the connections and settings. Check the input mode on the amplifier if you have connected one.</li> <li>● Press [AUDIO] to select the audio.</li> <li>● Turn off V.S.S. in the following cases. <ul style="list-style-type: none"> <li>— When using discs that do not have surround sound effects such as Karaoke discs.</li> <li>— When playing bilingual broadcast programmes.</li> </ul> </li> <li>● The disc may have a restriction on the method of audio output. If "D.MIX" does not appear in the display when playing multi-channel DVD-Audio, only audio for the two front channels will be output. Refer to the disc's jacket. <b>DVD-A</b></li> </ul>	7, 8, 41 22 27 —
<b>Cannot switch audio.</b>	<ul style="list-style-type: none"> <li>● You cannot switch the audio in the following cases. <ul style="list-style-type: none"> <li>— When a DVD-R disc is in the disc tray while DVD drive is selected.</li> <li>— When the recording mode is XP and "Audio Mode for XP Recording" is set to "LPCM".</li> </ul> </li> <li>● You have used a digital connection. Set "Dolby Digital" to "PCM" or connect using audio cables (analog connection).</li> <li>● There are discs for which audio cannot be changed because of how the disc was created.</li> </ul>	— 41 41, 8 —

Operation		Page
Cannot operate the television. The remote control doesn't work.	<ul style="list-style-type: none"> <li>●Change manufacturer code. Some televisions cannot be operated even if you change the code.</li> <li>●The remote control and main unit are using different codes. Change the code on the remote control.</li> </ul>	11
	 Press and hold [ENTER] and the indicated number button at the same time for more than 2 seconds.	11
	<ul style="list-style-type: none"> <li>●The batteries are depleted. Replace them with new ones.</li> </ul>	4
	<ul style="list-style-type: none"> <li>●Coloured glass may obstruct the signal reception/transmission.</li> <li>●Don't place the signal sensor in direct sunlight or in areas that may be subject to sunlight exposure.</li> </ul>	—
	<ul style="list-style-type: none"> <li>●The child lock function is activated.</li> </ul>	44
The unit is on but cannot be operated.	<ul style="list-style-type: none"> <li>●Recording drive or playback drive has not been selected properly.</li> <li>●Some operations may be prohibited by the disc.</li> <li>●The unit is hot ("U14" appears on the display). Wait for "U14" to disappear.</li> <li>●One of the unit's safety devices may have been activated.</li> </ul> Reset the unit as follows: Press [⏻/I] on the main unit to switch the unit to standby. If the unit doesn't switch to standby, press and hold [⏻/I] on the main unit for about 10 seconds. The unit is forcibly switched to standby. Alternatively, disconnect the AC mains lead, wait one minute, then reconnect it.	14, 20 — — —
Cannot eject disc.	<ul style="list-style-type: none"> <li>●The unit may have a problem. While the unit is off, press and hold [■] and [CH ^] on the main unit at the same time for about 5 seconds. Remove the disc and consult the dealer. If the Child Lock function is activated, above operation does not work. Cancel the Child Lock function.</li> </ul>	44
Cannot tune channels.	<ul style="list-style-type: none"> <li>●Check the connections.</li> </ul>	7

**Recording, timer recording and transferring (dubbing)**

Cannot record.	<ul style="list-style-type: none"> <li>●You haven't inserted a disc or the disc you inserted cannot be recorded on. Insert a disc the unit can record onto.</li> </ul>	12
	<ul style="list-style-type: none"> <li>●The disc is un-formatted. Format the disc. <b>RAM</b></li> </ul>	37
	<ul style="list-style-type: none"> <li>●The write-protect tab on the cartridge is set to PROTECT, or the disc is protected with DISC MANAGEMENT.</li> </ul>	36
	<ul style="list-style-type: none"> <li>●Some programmes have limitations on the number of times they can be recorded (CPRM).</li> </ul>	46
	<ul style="list-style-type: none"> <li>●The disc is full or nearly full. Erase un-needed titles or use another disc.</li> </ul>	22, 29, 36, 37
	<ul style="list-style-type: none"> <li>●You cannot record on finalized DVD-R discs.</li> <li>●Due to peculiarities of DVD-R, you may be unable to record onto them if you either insert and remove the disc or switch the unit on and off while a disc is loaded, a total of fifty times.</li> <li>●A DVD-R recorded on this unit may not be recordable on other Panasonic DVD recorders.</li> </ul>	— — —
	<ul style="list-style-type: none"> <li>●The timer programme is incorrect or different timer programme times overlap. Correct the programme.</li> </ul>	19
Timer recording does not work properly. G-CODE programming does not work properly.	<ul style="list-style-type: none"> <li>●The unit is not on timer recording standby. ("⊙" on the unit's display is not on.) Press [⊙ TIMER].</li> <li>●Set the clock.</li> </ul>	17, 18 43
	<ul style="list-style-type: none"> <li>●While using timer recording, press [⊙ TIMER]. ("⊙" disappears.)</li> </ul>	17, 18
Timer recording does not stop even when [■] is pressed.	<ul style="list-style-type: none"> <li>●The timer programme remains if set to daily or weekly.</li> </ul>	18
The timer programme remains even after recording finishes.	<ul style="list-style-type: none"> <li>●If there is a power failure or the plug is disconnected from the household AC mains socket while recording or editing, the title may be lost or the disc may become unusable. You will have to format the disc (<b>RAM</b>) or use a new disc. We cannot offer any guarantee regarding lost programmes or discs.</li> </ul>	—
A part or whole of a recorded title has been lost.	<ul style="list-style-type: none"> <li>●If images cannot be recorded or if the recording is aborted, check the connections and DV equipment settings.</li> <li>●You cannot start recording until the images from the DV equipment appear on the television.</li> <li>●Recording may not be performed as desired if the time codes on the tape in the DV equipment are not successive.</li> <li>●Depending on the equipment, the DV automatic recording may not operate properly.</li> </ul>	33 — — —
The DV automatic recording function does not work.		

Play

Page

<b>Play fails to start even when [▶] (PLAY) is pressed. Play starts but then stops immediately.</b>	<ul style="list-style-type: none"> <li>● Insert the disc correctly with the label facing up.</li> </ul>	20
	<ul style="list-style-type: none"> <li>● You tried to play a blank DVD-RAM/DVD-R, or disc unplayable on this unit.</li> </ul>	12
	<ul style="list-style-type: none"> <li>● When recording to DVD-RAM using "EP (8Hour)" mode, play may not be possible on DVD players that are compatible with DVD-RAM. In this case use "EP (6Hour)" mode.</li> </ul>	40
	<ul style="list-style-type: none"> <li>● You cannot play discs during DV automatic recording.</li> </ul>	—
<b>Audio and video momentarily pause.</b>	<ul style="list-style-type: none"> <li>● This occurs between play list chapters. <b>RAM</b></li> </ul>	—
<b>DVD-Video is not played.</b>	<ul style="list-style-type: none"> <li>● Some DVD-Video cannot be played when you change the ratings level.</li> </ul>	40
<b>Alternative soundtrack and subtitles cannot be selected.</b>	<ul style="list-style-type: none"> <li>● The languages are not recorded on the disc.</li> </ul>	—
	<ul style="list-style-type: none"> <li>● You may have to use the disc's menus to select languages.</li> </ul>	—
<b>No subtitles.</b>	<ul style="list-style-type: none"> <li>● Subtitles are not recorded on the disc.</li> </ul>	—
	<ul style="list-style-type: none"> <li>● Turn the subtitles on.</li> </ul>	26
<b>Angle cannot be changed.</b>	<ul style="list-style-type: none"> <li>● Angles can only be changed during scenes where different angles are recorded.</li> </ul>	—
<b>You have forgotten your ratings password.</b>	<ul style="list-style-type: none"> <li>● While the disc tray is open, press [DVD] then press and hold [◀◀/▶▶] and [▶▶/▶▶] on the main unit at the same time for 5 or more seconds.</li> </ul>	—
<b>Quick View does not work.</b>	<ul style="list-style-type: none"> <li>● This does not work if the setting is "Off" in "PLAY × 1.3 &amp; Audio during Search".</li> </ul>	41
	<ul style="list-style-type: none"> <li>● This does not work when audio is other than Dolby Digital.</li> </ul>	—
	<ul style="list-style-type: none"> <li>● This does not work when recording is in XP or FR mode. <b>RAM</b></li> </ul>	—
<b>The resume play function does not work.</b>	<ul style="list-style-type: none"> <li>● This function only works when the indicator on the right appears on the unit display.</li> </ul>	—
	<ul style="list-style-type: none"> <li>● Memorized positions are canceled when the unit is turned off or when the tray is opened. The memorized position on the play list is also canceled when the play list and title are edited.</li> </ul>	—
<b>The Video CD picture does not display properly.</b>	<ul style="list-style-type: none"> <li>● When connecting to Multi-system TV, select "NTSC" in "TV System" in the SETUP menu.</li> </ul>	43
	<ul style="list-style-type: none"> <li>● When connecting to PAL TV, the lower part of the picture cannot be displayed correctly during search.</li> </ul>	—
<b>Time Slip does not work.</b>	<ul style="list-style-type: none"> <li>● Time Slip does not work when the unit's "TV System" settings are different from the title recorded on the disc.</li> </ul>	43



Edit

<b>Cannot format.</b>	<ul style="list-style-type: none"> <li>● The disc is dirty. Use a special cleaner and wipe clean.</li> </ul>	44
	<ul style="list-style-type: none"> <li>● You tried formatting a disc that is not compatible with this unit.</li> </ul>	12
<b>Cannot create chapters.</b>	<ul style="list-style-type: none"> <li>● The unit writes the chapter information to the disc when you turn it off or remove the disc. The information is not written if there is an interruption to the power before this.</li> </ul>	—
<b>Cannot mark the start point or the end point during "Partial Erase" operation.</b>	<ul style="list-style-type: none"> <li>● These operations are not possible with still pictures.</li> </ul>	—
	<ul style="list-style-type: none"> <li>● You cannot set points if they are too close to each other. You cannot set an end point before a start point.</li> </ul>	—
<b>Cannot erase chapters.</b>	<ul style="list-style-type: none"> <li>● When the chapter is too short to erase, use "Combine Chapters" to make the chapter longer.</li> </ul>	29
<b>The available recording time doesn't increase even after erasing recordings on the disc.</b>	<ul style="list-style-type: none"> <li>● Available recording space on the DVD-R does not increase even after erasing previously recorded titles.</li> </ul>	—
<b>Cannot create a play list.</b>	<ul style="list-style-type: none"> <li>● You cannot select all the chapters at once in a title if the title also includes still pictures. Select them individually.</li> </ul>	—

Still pictures

<b>Cannot display Direct Navigator screen.</b>	<ul style="list-style-type: none"> <li>● This screen cannot be displayed during recording.</li> </ul>	—
<b>Cannot edit or format a card.</b>	<ul style="list-style-type: none"> <li>● Release the card's protection setting. (With some cards, the "Write protection Off" message sometimes appears on the screen even when protection has been set.)</li> </ul>	36
<b>The contents of the card cannot be read.</b>	<ul style="list-style-type: none"> <li>● The card format is not compatible with the unit. (The contents on the card may be damaged.)</li> </ul>	13, 24
	<ul style="list-style-type: none"> <li>● Format using FAT 12 or FAT 16 with other equipment or format the card with this unit.</li> </ul>	37
	<ul style="list-style-type: none"> <li>● The card contains a folder structure and/or file extensions that are not compatible with this unit.</li> </ul>	13
	<ul style="list-style-type: none"> <li>● Turn off and then turn on the unit again.</li> </ul>	—
<b>Transferring (dubbing), erasing and setting protection takes a long time.</b>	<ul style="list-style-type: none"> <li>● When there are a lot of folders and files, it may sometimes take a few hours.</li> </ul>	—
	<ul style="list-style-type: none"> <li>● When repeating transferring (dubbing) or erasing, it may sometimes take a long time. Format the disc or card.</li> </ul>	37
<b>The PC card cannot be removed.</b>	<ul style="list-style-type: none"> <li>● Make sure the PC card is slotted home firmly before attempting to remove.</li> </ul>	24

# Index

<b>Angle</b> .....	26	<b>Finalize</b> .....	37, 46	<b>Quick View</b> .....	21
<b>Aspect</b> .....	10	<b>Flexible Recording</b> .....	16	<b>Ratings level</b> .....	40
<b>Audio</b>		<b>Format disc</b> .....	37, 46	<b>Recording</b> .....	14
Attribute .....	26	<b>FR (Flexible Recording Mode)</b> .....	15	DV automatic recording .....	33
Language .....	40	<b>FUNCTIONS window</b> .....	35	Flexible Recording .....	16
Playback .....	22	<b>JPEG</b> .....	24, 46	Mode .....	15
Receiving .....	27	<b>G-CODE</b> .....	17	Timer .....	17–19
<b>Change Thumbnail</b> .....	29	<b>Language</b>		<b>Remote control code</b> .....	11
<b>Channel</b>		Audio .....	40	<b>Repeat play</b> .....	27
Audio .....	26	Code list .....	42	<b>Resume play function</b> .....	21
Auto-Setup .....	9, 43	Soundtrack .....	26, 40	<b>SD card</b> .....	13
<b>Chapter</b> .....	22, 28	Subtitle .....	26, 40	<b>SETUP menu</b> .....	39
<b>Chasing playback</b> .....	15	<b>LPCM</b> .....	41, 46	<b>Shipping Condition</b> .....	39
<b>Child Lock</b> .....	44	<b>Manual Skip</b> .....	21	<b>Simultaneous rec and play</b> .....	15
<b>Cleaning</b>		<b>Menu</b>		<b>Soundtrack</b> .....	26
Disc .....	44	MP3 .....	23	<b>Status messages</b> .....	27
Lens .....	44	On-screen .....	26	<b>Still picture</b>	
Main unit .....	44	SETUP .....	39	Edit .....	32
<b>Clock settings</b> .....	43	<b>Mode</b>		Play .....	24
<b>Connection</b>		Recording .....	15	Transferring (dubbing) .....	34
Aerial .....	7	Still Mode .....	40	<b>Subtitle</b> .....	26
Amplifier, system component .....	8	<b>MP3</b> .....	23	<b>TIFF</b> .....	24, 46
AV3 input terminals .....	33	<b>Noise reduction (NR)</b>		<b>Time Slip</b> .....	15, 21
DV input terminal .....	33	AV-in NR .....	40	<b>Timer recording</b> .....	17–19
Television .....	7	Playback NR .....	27	<b>Transfer</b> .....	27
Video cassette recorder .....	7, 33	<b>On-screen</b>		<b>Transfer (dubbing) still picture</b> .....	34
<b>Copy (play list)</b> .....	31	Menus .....	26	<b>Tuning</b>	
<b>Country setting</b> .....	9	Status messages .....	27	Auto-Setup .....	9, 43
<b>CPRM</b> .....	46	<b>Partial Erase</b> .....	29	Manual .....	42
<b>Create Chapter</b> .....	22, 29	<b>PC card</b> .....	13	<b>TV System (PAL/NTSC)</b> .....	43
<b>Create play lists</b> .....	30	<b>PCM Down Conversion</b> .....	41	<b>TV type</b> .....	10
<b>Default Settings</b> .....	39	<b>Picture settings</b> .....	27, 40	<b>V.S.S.</b> .....	27
<b>Dialog Enhancer</b> .....	27	<b>Play list</b> .....	30		
<b>Direct Navigator</b> .....	20, 25, 28, 32	<b>Playback NR</b> .....	27		
<b>Divide Title</b> .....	29	<b>Power Save</b> .....	39		
<b>DPOF</b> .....	32, 46	<b>Progressive</b> .....	10, 27, 42, 46		
<b>DV automatic recording</b> .....	33	<b>Properties</b>			
<b>DVD-R (Enabling DVD-R to be played on other equipment—Finalize)</b> .....	37	Play list .....	31		
<b>DVD-RAM, DVD-R</b> .....	12	Still picture .....	25		
		Title .....	29		
<b>Enter name</b>		<b>Protection</b>			
Disc .....	36	Card .....	36		
Entering text .....	38	Cartridge .....	36		
Folder .....	32	Disc .....	36		
Play list .....	31	Folder .....	32		
Title .....	17, 18, 29	Still picture .....	32		
<b>Erase</b>		Title .....	29		
All titles .....	36				
Chapter .....	22, 29, 31				
Folder .....	32				
Play list .....	22, 31				
Still picture .....	32				
Title .....	22, 29				

Manufactured under license from Dolby Laboratories. "Dolby" and the double-D symbol are trademarks of Dolby Laboratories.

"DTS" and "DTS 2.0+Digital Out" are trademarks of Digital Theater Systems, Inc.

G-CODE is a registered trademark of Gemstar Development Corporation. The G-CODE system is manufactured under license from Gemstar Development Corporation.

MPEG Layer-3 audio decoding technology licensed from Fraunhofer IIS and Thomson multimedia.

This product incorporates copyright protection technology that is protected by method claims of certain U.S. patents and other intellectual property rights owned by Macrovision Corporation and other rights owners. Use of this copyright protection technology must be authorized by Macrovision Corporation, and is intended for home and other limited viewing uses only unless otherwise authorized by Macrovision Corporation. Reverse engineering or disassembly is prohibited.

- SD logo is a trademark.
- Portions of this product are protected under copyright law and are provided under license by ARIS/SOLANA/4C.